

---

**TURFGRASS RESEARCH  
CONFERENCE AND FIELD DAY**

September 14, 1999

---

**&**

**LANDSCAPE MANAGEMENT  
RESEARCH CONFERENCE**

**AND FIELD DAY**

September 15, 1999

---



University of California, Riverside  
Cooperative Extension  
Dept. of Botany and Plant Sciences  
Agricultural Operations

**TURFGRASS RESEARCH CONFERENCE  
AND FIELD DAY**

**TUESDAY, SEPTEMBER 14, 1999**

**TURFGRASS RESEARCH CONFERENCE AND FIELD DAY  
SEPTEMBER 14, 1999**

**TABLE OF CONTENTS AND CONFERENCE SCHEDULE**

<b>8:00 a.m.</b>	<b>Registration</b>	
<b>8:50</b>	<b>Welcome and Announcements</b> <i>Victor Gibeault</i>	
<b>9:00</b>	<b>Kikuyugrass Management Update</b> .....	<b>1</b>
	<i>David Cudney</i>	
<b>9:20</b>	<b>Contact Transfer of Pesticides: Turf Indoors and in the Field</b> .....	<b>5</b>
	<i>Robert Krieger</i>	
<b>9:40</b>	<b>Overview of a New Environmental Issues Project</b> .....	<b>6</b>
	<i>Janet Hartin</i>	
<b>10:00</b>	<b>Best Management Practices for Tall Fescue Irrigation and Nitrogen Fertility</b> .....	<b>9</b>
	<i>Robert Green</i>	
<b>10:20</b>	<b>BREAK</b>	
<b>11:00</b>	<b>Issues Related to Recycled Water for Turf Use</b> .....	<b>17</b>
	<i>Marylynn Yates</i>	
<b>11:20</b>	<b>Urban Waste Based Soil Amendments for Horticulture Use</b> .....	<b>18</b>
	<i>Andrew Chang</i>	
<b>11:40</b>	<b>Retractable Roof Research Wrapup</b> .....	<b>21</b>
	<i>Stephen Cockerham</i>	
<b>12 noon</b>	<b>LUNCH</b>	
<b>12:45 p.m.</b>	<b>Drive Your Own Car to Agricultural Experiment Station</b>	
<b>1:30</b>	<b>Organizational Comments</b>	
<b>Stop #1</b>	<b>Sports Field Management Overview</b> .....	<b>36</b>
	<i>Stephen Cockerham and George Riechers</i>	
<b>Stop #2</b>	<b>Sports Traffic and Shade</b> .....	<b>38</b>
	<i>Steve Ries</i>	
<b>Stop #3</b>	<b>Tall Fescue Best Management Practices Field Study</b> .....	<b>39</b>
	<i>Grant Klein</i>	
<b>Stop #4</b>	<b>Irrigation Practices and Water Conservation Opportunities</b> .....	<b>43</b>
	<i>William Richie</i>	
<b>Stop #5</b>	<b>Fall Bermudagrass Management for Color Retention</b> .....	<b>45</b>
	<i>Victor Gibeault</i>	
<b>Stop #6</b>	<b>Tall Fescue Cultivar Performance</b> .....	<b>47</b>
	<i>Mike Henry</i>	

# The Development of the University of California, Riverside Plots is Largely Due to the Generosity of the Firms and Organizations Shown Here



CALIFORNIA  
SOD  
PRODUCERS  
ASSOCIATION



California GCSA



LIDAG  Laboratorio de Investigaciones y Diagnósticos Agropecuarios, S.A. de C.V.

WEST COAST  
TURF

Agrevo

Hunter

STOVER  
S.E.E.D. COMPANY



G pbi / GORDON CORPORATION

WESTERN TURF  
JACOBSEN TETRA

N  
T  
E  
P

OMC Lincoln



IRROMETER

ZENECA

CALIFORNIA TURF

TORO

FIRST PRODUCTS INC.

SEEDS  
West INC.



Southern California  
Turfgrass Foundation

Rogers Innovative Inc.



RHÔNE-POULENC

BASF

BEST



GERMAIN'S SEEDS

PURELL TECHNOLOGIES INC.

EARTH PLUS

Bayer

RAIN-BIRD

## KIKUYUGRASS UPDATE

David W. Cudney<sup>1</sup>, Clyde L. Elmore<sup>2</sup>, and Victor A. Gibeault<sup>1</sup>

<sup>1</sup>Dept. of Botany and Plant Sciences, University of California, Riverside, CA 92521-0124

<sup>2</sup>Dept. of Vegetable Crops, University of California, Davis, CA 95616

Kikuyugrass (*Pennisetum clandestinum*) is an extremely aggressive perennial weed of turfgrass, ornamental plantings, orchards, and non-crop areas in California. A native African grass, it is well adapted to warm, temperate climates such as those of the coast and inland valleys of Southern and Central California. It was originally imported in about 1918 as a ground cover to reduce erosion on ditch banks. With its rapid stolon growth and thatch formation, it rapidly moved from these sites to become a serious weed pest. In the early days it was often confused with St Augustinegrass and may have been mistakenly propagated and planted as St Augustine.



Figure 1. Kikuyugrass stolon

### Identification and Life Cycle

Kikuyugrass (Fig. 1) is a perennial plant that grows best under cool to warm (60-90F), moist conditions. However, kikuyugrass will survive well in high temperatures (100+F). Kikuyugrass has a C4 photosynthetic pathway, like bermudagrass, which gives it a high carbohydrate assimilation rate and growth rate at high light intensity and warm temperature. But, unlike bermudagrass, kikuyugrass is able to maintain a steady growth rate at lower temperatures. In coastal areas kikuyugrass may not go dormant in winter. In the inland valleys of California, it will turn brown in late November and remain dormant until February or March, depending on the temperature. After "green up", its growth rate increases in late spring, reaching and maintaining a rapid growth rate in early summer through early fall. When growing rapidly, kikuyugrass is capable of sustained shoot growth rates exceeding one inch per day. Flowering begins in late spring and is stimulated by mowing. Seed production continues throughout the summer and fall.

Kikuyugrass is a prostrate plant, producing a network of thick, fleshy stems (Fig. 1). These stems often may form a thick mat or thatch above the soil surface (stolons) or a network of buried stems from one to four inches deep in the soil (rhizomes). Carbohydrates are stored in

the stems. The carbohydrates can be utilized for regrowth after mowing or cultivation. If the stems are chopped into small pieces, each stem section is capable of producing new shoots and roots from its nodes. Thus kikuyugrass can easily be moved from one area to another by mowing and renovation equipment. Kikuyugrass, left un-mowed, can attain a height of about 18 inches, however it can grow up over fences and into trees and shrubs. When mowed, kikuyugrass will survive cutting heights of less than ½ inch.

**Figure 2. St Augustine with folded blunt leaves compared to the flat, pointed leaves of kikuyugrass**

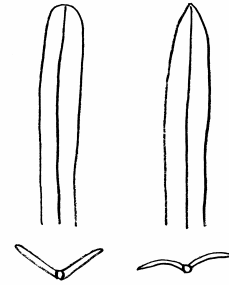

Leaves of kikuyugrass are light green in color and vary from ½ inch to 10 inches in length. Leaf tips are pointed and leaf blades are flat and about 1/8-1/4 inches in width (Fig.2). This varies from St. Augustinegrass, which has rounded leaf tips with sharply folded or creased leaf blades. Another identifying characteristic of kikuyugrass is in the leaf collar region where a long fringe of hairs, parallel the stem (Fig. 3).

**Figure 3. kikuyugrass leaf with ridge of hairs at collar**

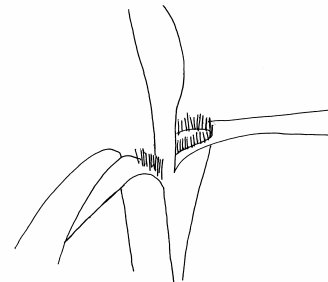

The male flower parts or anthers (Fig. 4) extend above the turf surface on slender filaments and give the infested areas a whitish cast. Seed is produced beneath the mowed surface in turf and is dark brown and about 1/8 inch in length with a rather large scar at its rounded base.

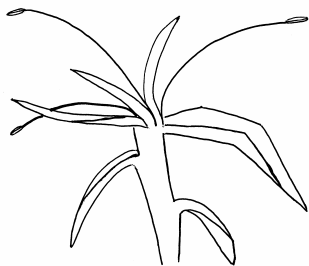

**Figure 4. kikuyugrass anthers protruding from stem**

## **Impact**

Kikuyugrass is a major weed problem for turf, ornamental, and orchard managers in the coastal and inland valleys of southern and central California. In Turf it forms thick mats that crowd out desirable species. The thick mat makes use for golf or other athletic use difficult and in some cases dangerous. The light green color and coarse texture of kikuyugrass is not esthetically desirable. In golf courses it often invades greens, making hand removal necessary. In ornamental areas it invades ground covers and flowerbeds often completely choking them out. Kikuyugrass can grow up into low shrubs reducing their vigor and blocking out light. In orchards it can compete for nutrients with the crop, interfere with irrigation by blocking sprinklers and emitters, block drainage ditches and overgrow fences.

## **Management**

The best way to control kikuyugrass is to prevent its spread into new areas. Kikuyugrass can be disseminated both from seed and from stem sections. Contaminated mowing, cultivation, and renovation equipment seems to be the most common method of spread. Clean equipment before moving it from infested areas to new areas as it may be contaminated with kikuyugrass seed or stem sections. Kikuyugrass has also been spread in contaminated soil, sod, and planting stock. Make sure that any incoming materials are free of contamination. Turf and ornamental areas should be well maintained to assure maximum vigor. This will aid in making these plantings as competitive as possible to slow invasion of the weed. Dense turf and ornamentals will shade the soil surface making the establishment of kikuyugrass sprigs and seedlings more difficult. Orchards and non-crop areas should be regularly inspected for the presence of invading weed species. Species such as kikuyugrass should be removed by hand or spot treated to prevent their spread.

Kikuyugrass cannot be controlled with a single treatment or procedure in turf. Early grubbing of solitary infestations has been successful when practiced diligently. Spot spraying isolated plants with glyphosate can be helpful, but the turf is killed leaving open areas, making kikuyugrass reestablishment easier. The open spots should be over-seeded to establish a vigorous turf.

Preemergence (pendimethalin, prodiamine, bensulide, and benefin) herbicides have been successful in limiting germination of kikuyugrass seeds. But most of the spread of this pest is from stem sections. These herbicides could be applied in March to limit germination in spring and early summer.

Postemergence herbicides can reduce kikuyugrass infestations in cool season turf (tall fescue, perennial ryegrass, and Kentucky bluegrass). But three to four sequential applications per year are necessary for control. Best control has been obtained from sequential applications (spaced four to six weeks apart) of a combination of triclopyr and MSMA. Sequential applications of either MSMA or triclopyr alone will reduce kikuyugrass vigor and growth but not to the extent of the combination. Sequential applications of fenoxaprop have also been effective in reducing kikuyugrass. The only selective postemergence treatment option for reducing kikuyugrass invasion in bermudagrass turf has been sequential application of MSMA. Research has shown that quinchlorac will reduce kikuyugrass infestations in both cool and warm season turf, however it has yet to become registered for use in California.

## References

- Cudney, D. W., J. A. Downer, V. A. Gibeault, J. M. Henry, C. L. Elmore, and J. S. Reints. 1994. Herbicide program can control kikuyugrass in cool-season turf. *Calif. Agric.* 48(2): 24-28.
- Cudney, D. W., J. A. Downer, V. A. Gibeault, J. M. Henry, and J. S. Reints. 1993. Kikuyugrass (*Pennisetum clandestinum*) management in turf. *Weed Tech.* 7(1): 180-184.
- Cudney, D. W., V. A. Gibeault, R. L. Baldwin, and J. R. Breece. 1982. Chemical and cultural control of kikuyugrass in turf. *Calif. Agric.* 36(1): 4-5.
- Elmore, C. L., V. A. Gibeault, and D. W. Cudney. 1997. Invasion resistance of tall fescue (*Festuca arundinaceae*) and perennial ryegrass (*Lolium perenne*) to kikuyugrass (*Pennisetum clandestinum*). *Weed Tech.* 11(1): 24-29.



## **CONTACT TRANSFER OF PESTICIDES: TURF INDOORS AND IN THE FIELD**

**Robert I. Krieger**

*Dept. of Entomology, University of California, Riverside, CA 92521-0124*

Use of chemical pesticides and fertilizers in turf management is increasingly the subject of conjecture and inadequately supported risk management assumptions. Data concerning potential human exposure are sought by regulators and risk managers concerned about chemical exposures, health, and the well-being of maintenance workers, golfers, other patrons and staff, as well as bystanders who live in the vicinity. We have found that the transfer of pesticide residues from treated surfaces (indoors, turf, or treated plants in agriculture) results in similar, low level human exposures. Inventory of the exposure potential of activities associated with turfgrass management can be used to reduce concerns about possible health consequences of human exposure. Use of this process of estimating exposure for several chemicals of apparently destined for restricted use will be used to illustrate how readily available information can mitigate apparent exposure and yield more representative data for risk management.

<b>EXPOSURE ASSESSMENT: REFOCUSING DEFAULTS ASSUMPTIONS ON REALITY</b>		
<b>ACTIVITY</b>	<b>DEFAULT</b>	<b>FOCUSED</b>
Pesticide formulation		
Application equipment (field ag vs. turf)		
Application rate		
Frequency and duration of use		
Entry requirements (time and clothing)		
Nature of surface contact		
Extent of chemical transfer		
Potential absorbed dose		
Skin contact		
Inhalation		
Bystander		
Estimated absorbed dosage		
Margin of exposure		

## OVERVIEW OF A NEW ENVIRONMENTAL ISSUES PROJECT

Janet Hartin

University of California Cooperative Extension, San Bernardino and Los Angeles Counties  
777 E. Rialto Avenue, San Bernardino, CA 92415-0730

During the past 15 years, the United States Golf Association (USGA) Turfgrass and Environmental Research Program allocated nearly \$15 million to fund research projects involving environmental problems and issues and golf course maintenance. USGA-sponsored projects have generated over 100 related scientific and technical articles. While the rate and quality of these publications is impressive, of particular interest to Cooperative Extension is the actual adoption of recommended practices and principles by golf course superintendents and greenskeepers. In recognition of this need, the author received funding from the USGA in 1998 to develop an educational program specifically oriented to golf course superintendents in Southern California based on results of USGA funded research. This three-year project focuses on increasing the adoption of USGA-sponsored research concerning water quantity and quality, pesticide and nutrient fate and alternative pest management systems by golf course superintendents and greenskeepers.

The initial phase of the project entails consolidating research results and authoring new publications stressing applications of the results to golf course superintendents, while the focus of the second and third phases include conducting a series of workshops to facilitate dissemination of the results in an audio-visual format. A brief review of information included in each major publication category follows:

### ***Water Quantity***

**Background.** Large amounts of irrigation water are often wasted due to poor sprinkler distribution uniformity and lack of scheduling irrigations based on evapotranspiration. Properly scheduling turfgrass irrigations can reduce water waste, increase the performance of golf course turfgrass, and reduce pest problems. Irrigation scheduling entails applying the correct amount of water in a timely way, based on turfgrass evapotranspiration (ET) and soil conditions.

Maintaining high sprinkler distribution uniformity is crucial for optimum turfgrass performance and reducing water waste. While a modern, multi-valve system with numerous controllers can fine-tune an irrigation schedule, large amounts of water may still be lost due to mechanical and/or physical problems with the system. Common irrigation system problems leading to poor water distribution include: broken sprinkler heads; non-vertical sprinkler heads; mismatched heads and nozzles; clogged nozzles; broken valves and piping; improper sprinkler head spacing; and, incorrect pumping station and operational pressure. Often, remedying these problems can improve distribution uniformity by 20 percent or more.

**Relevant Information Included in New Educational Program.** Two methods of scheduling turfgrass irrigation based on turfgrass evapotranspiration, using either real-time or historical reference ET ( $ET_0$ ), are discussed. *Method One* involves conducting a catchment test to determine the precipitation rate of the sprinkler system, and matching this output with the length of irrigation listed in an accompanying table, based on historical reference ET ( $ET_0$ ) for three climatic zones in Southern California.

*Method Two* offers a more precise method of calculating irrigation needs than *Method One*, and offers accuracy under unusual weather patterns, but requires the golf course superintendent to mathematically determine the on-site distribution uniformity (DU), application rate, net amount of water to apply, and sprinkler run time. It offers the option of utilizing the California Irrigation Management Information System (CIMIS) and incorporates the use of tensiometers.

Information on conducting catchment can tests to determine precipitation rates and distribution uniformities and walk-through evaluations to identify and rectify irrigation hardware problems are discussed in detail.

### ***Water Quality***

**Background.** The quality of water used to irrigate golf course turfgrass is directly related to its growth, development, and performance. Components of water quality include salt concentration, sodium hazard, bicarbonate content, toxic ion concentration and water pH. Research has shown that, while almost all irrigation water contains dissolved salts and other chemicals, detrimental effects occur beyond certain levels, which vary among chemicals and species of turfgrass.

Most problems resulting in salt accumulation in turfgrasses relate to their transport in irrigation water. Irrigating turfgrass with effluent water has gained popularity in many areas of Southern California; while this practice offers many dividends such as recycling a valuable resource and adding nutrients to the soil, it may increase salinity and should be monitored closely.

**Relevant Information Included in New Education Program.** Due to increased interest and emphasis on use of effluent water as a source of irrigation water for golf courses, a discussion of sampling procedures, specific analyses to request, and a comprehensive listing of laboratories with the capacity to perform analytical water quality tests in Southern California is included. Information regarding the interpretation of test results and critical levels of specific ions and related implications on golf course turfgrasses is included, along with conversion charts. Because a common result of effluent water tests is the detection of high levels of dissolved salts, management options including various irrigation scheduling regimes emphasizing leaching are highlighted.

### ***Pesticide and Nutrient Fate***

**Background.** Understanding and quantifying the fate of pesticides and fertilizers in runoff and groundwater aids in determining the extent of current and predicted environmental impacts of golf courses. Protecting groundwater and surface water from chemical pollutants is a priority of golf course superintendents. Although over 70 percent of the pesticides applied in agricultural operations are for the production of food and fiber, there has been increased public concern in recent years about the ramifications of chemical use in all settings, including those requiring intense maintenance, such as golf courses. In 1991, the USGA initiated a three year study to: investigate the fate of pesticides and fertilizers applied to golf course turfgrasses; develop alternative non-chemical methods of pest control; and, determine the impact of golf courses on people and wildlife. Eleven university research projects were funded in these areas. In general, the measured nitrogen and pesticide leaching in the simulated golf course turfgrass plantings was minimal and within federal clean water guidelines. However, heavy irrigation or rainfall subsequent to pesticide applications can result in leaching of some chemicals, particu-

larly in sandy soils, emphasizing the importance of employing recommended cultural management practices.

**Relevant Information Included in New Publication.** Results and implications of these university research projects involving pesticide and nutrient fate relevant to Southern California golf course superintendents are reported. Included are studies conducted at the University of California-Riverside under the direction of Dr. Marylynn Yates.

The relative importance of processes influencing chemical fates and related optimum cultural management practices are discussed. Irrigation management is a key factor in pesticide movement, since soil moisture content that is equal to or in excess of field capacity at the time of pesticide application increases runoff potential. Practices such as irrigation sequencing before and just after pesticide applications, selecting low toxicity pesticides when feasible, correctly timing pesticide and fertilizer applications, and, reducing chemical losses in surface runoff by maintaining buffers downslope from treated areas are discussed.

***Alternative Pest Management Systems.***

**Background:** Alternative pest management (APM) methods potentially reduce the amount of pesticide necessary to maintain viable golf course turfgrass. Several USGA-sponsored APM projects developed and evaluated various scenarios of disease and insect control including use of cultural and mechanical practices, allelopathy, selective breeding for pest resistance, ecological balance of plant species in turfgrass swards, and biological control. Examples include studies aimed at: improving creeping bentgrass through genetic transformation; identifying parasitic bacteria as potential biological control agents against Summer Patch Disease (*Magnaporthe poae*); cultural control of white grubs and cutworms; allelopathic control of crabgrass by perennial ryegrasses; and, biological control of Sting Nematode (*Belonolaimus longicaudatus*).

**Relevant Information Included in New Publication:** Applicable information from USGA-sponsored APM studies was coupled with updated University of California Turfgrass Pest Management Guidelines to produce comprehensive guidelines for controlling major diseases, insects, and weeds that impact Southern California golf course turfgrasses.

## **BEST MANAGEMENT PRACTICES FOR TALL FESCUE IRRIGATION AND NITROGEN FERTILITY**

**Robert L. Green<sup>1</sup>, Grant J. Klein<sup>1</sup>, William E. Richie<sup>1</sup>, Janet S. Hartin<sup>2</sup>, and Victor A. Gibeault<sup>1</sup>**

<sup>1</sup>*Dept. of Botany and Plant Sciences, University of California, Riverside, CA 92521-0124*

<sup>2</sup>*University of California Cooperative Extension, San Bernardino and Los Angeles Counties  
777 E. Rialto Avenue, San Bernardino, CA 92514*

This project involves the study and development of best management practices (BMPs) for landscape water conservation and nitrogen (N) fertility efficiency on tall fescue, currently the most widely planted turfgrass species in California. We believe this subject is worthy of investigation because water use is the most important environmental issue in California and it is consistent with the goal of improving crop-water management and fertilizer-use efficiency. The objectives of this 3-year project are listed below.

### **Objectives**

1. Test irrigating tall fescue at a defined annual amount (80% historical  $ET_0$  plus rain) with increased irrigation during the warm season to improve grass performance, and then proportionally adjusting the cool-season irrigation amount downward to make up for the addition of warm-season irrigation. These treatments are compared to irrigating tall fescue at a constant rate of 1) 80% historical  $ET_0$  plus rain and 2) 80%  $ET_0$  plus rain (80%  $ET_0$  (real time) plus rain). (Please see Tables 1 and 2).

Treatments B and C would be considered "water banking" treatments because there is an increased irrigation amount during the warm season to improve tall fescue performance, and then proportionally adjusting the cool-season irrigation amount downward to makeup for the addition of warm-season irrigation. It should be noted that 80% historical  $ET_0$  plus rain and 80%  $ET_0$  plus rain irrigation treatments would be comparable to 100% historical  $ET_0$  plus rain and 100%  $ET_0$  plus rain, respectively, for most landscape sites because the distribution of uniformity (DU) of the irrigation system of the research plots is probably 20% higher than the DU of the irrigation system of most landscapes.

2. In conjunction with irrigation treatments, test the influence of the annual N-fertility rate on the performance of tall fescue (Please see Tables 1 and 2).
3. Quantify the effects of irrigation and N-fertility treatments on tall fescue visual appearance and drought stress tolerance, growth (clipping yield) and N uptake, along with treatment effects on soil water content and soil N status.
4. Develop BMPs for tall fescue relating to turfgrass water conservation and N-fertilizer use efficiency, which provide optimal performance in terms of visual quality and drought stress tolerance, growth (clipping yields), and N uptake.

---

This research is funded in part by the 1) State of California Department of Food and Agriculture, Fertilizer Research and Education Program, and 2) The Metropolitan Water District of Southern California. Thanks are given to the Soil and Plant Laboratory, Inc., Orange, CA, for providing N tissue analysis.

5. Conduct outreach activities, including trade journal publications and oral presentations, emphasizing the importance of turfgrass BMPs, and how to properly carry out these practices for turfgrass irrigation and N fertilization.

### **Results from the 1998 Field Study**

Selected results from the first year show several trends.

1. During the critical 3-month quarter of July to September, the water banking treatments (irrigation treatments B and C, Table 1) performed as well as the 80% ET<sub>o</sub> (real-time) plus rain irrigation treatment. Performance was based on the number of rating dates that visual turfgrass quality and color was  $\geq 5.5$  on a 1 to 9 scale. A rating of 1 is the poorest quality and a rating of 9 is the best quality, while a rating of 5 is minimum acceptable quality. Also, a rating of 1 is brown color and a rating of 9 is best dark green color, while a rating of 5 is minimum acceptable color.

The water banking treatments had one irrigation clock change on July 1, while the 80% ET<sub>o</sub> (real time) plus rain irrigation treatment had weekly irrigation clock changes. The former treatments may be more realistic to the needs of the industry.

2. Treatment A, the constant 80% historical ET<sub>o</sub> plus rain had the poorest performance among all irrigation treatments during the 3-month quarter of July to September. Performance was based on the number of rating dates that visual turfgrass quality and color was  $\geq 5.5$  on a 1 to 9 scale. During this time, the soil water content at the 9- to 24-inch depth for treatment A was lowest (dry) among all irrigation treatments.
3. During the October to December 3-month quarter, the water banking treatments had the poorest performance among the irrigation treatments. Performance was based on the number of rating dates that visual turfgrass color was  $\geq 5.5$ , on a 1 to 9 scale. The poor performance was due to a lack of irrigation during the October to December 3-month quarter.

Considering the historical rainfall patterns shown in Table 2, more irrigation should be allotted to the water banking irrigation treatments during the October to December 3-month quarter. It should also be noted that the rainfall amount during October to December 1998 was 70% lower than the historical amount (Table 3).

4. The 6.0 lb N/1000 ft<sup>2</sup> per year N-fertility treatment had significantly higher visual turfgrass quality and color ratings than the 3.0 and 4.5 lb N/1000 ft<sup>2</sup> per year treatments. Actually, both the visual turfgrass quality and color of the latter treatments were poor.

### **Conclusions from the 1998 Field Study**

Based on the findings from the first year, we are implementing revised water banking irrigation treatments for 1999 and 2000 (please see irrigation treatments B and C, Table 2). These treatments are designed for the most water banking during the January to March 3-month quarter when the historical rainfall amount is 5.55 inches. Also, more irrigation has been allotted to the October to December 3-month quarter because less rainfall occurs during this time.

The maintenance of shoot growth and plant vigor by providing a good N-fertility program is especially important for the potential drought stress conditions that may occur during reduced irrigation. We conclude that the annual N rates, ranging from 3.0 to 6.0 lb N/1000 ft<sup>2</sup>, were too low, and that we should substitute the quick-release N sources to slow-release N sources (Please see Table 2).

This suggests that as water budgets become more prevalent in California, N-fertility programs may need to be adjusted.

### **ANALYSIS OF 1998 TURFGRASS BEST MANAGEMENT PRACTICES SURVEY FORM Grant Klein**

**Surveys were handed out at the UCR Turfgrass Research Conference and Field Day; The SCTC Turfgrass, Landscape, and Equipment Expo Workshops; and the SCTC Turfgrass and Landscape Institute. The following results were based on 218 to 247 respondents, depending on the number of valid responses to each question.**

#### ***Identifying the audience***

The primary target audience was present for these presentations, as shown by the survey results. A total of 42.6% indicated they were government (public property) site managers. Golf course managers followed at 16.6%, after which there were 9.4% commercial site managers, 8.1% manufacturers or sales representatives of turfgrass-related products (fertilizers, mowers, irrigation equipment, etc.), 6.3% professional consultants and horticultural advisors, 4.9% turfgrass producers (sod farms, etc.), and 3.6% providers of professional residential lawn care. A total of 2.7% indicated "other". Several popular write-in categories included researchers (2.7%), seed producers (1.8%), and sports turf managers (1.3%). These three categories will be incorporated into future surveys.

The respondents had a moderate amount of experience with turfgrass, averaging 12.8 years. Individuals with 6 to 15 years of experience composed 38.9% of the sample, followed by those with 0-5 years (29.1%), 16-25 years (24.7%), and 26 or more years of experience (7.3%).

Although respondents were from as far away as Colorado, Arizona and Nevada, the vast majority (97.1%) were from California. Most of the respondents were from counties in southern California (90.5%), including 23.9% from Los Angeles County, 18.8% from Orange County, 18.8% from San Diego County, 16.5% from Riverside County, 6.0% from San Bernardino County, 3.7% from Santa Barbara County, and 2.8% from Ventura County.

The majority of the respondents were also those individuals which are responsible for making turfgrass management decisions or recommendations, and are an important part of the primary audience the presentations were attempting to reach. A total of 53.5% indicated they always were responsible for the decisions or recommendations, and 32.8 % indicated they were usually responsible. Only 11.2% indicated they were rarely responsible, and 2.5% indicated they were never responsible for turfgrass management decisions or recommendations.

The survey respondents also managed a wide variety of turfgrass species. More than half of the respondents indicated they managed bermudagrass (71.1%) and tall fescue (59.0%). The

other popular species included ryegrass (40.6%), kikuyugrass (33.9%), creeping bentgrass (21.8%) and *poa annua* (20.1%). It should be noted that bluegrass (other than *poa annua*) (5.0%), zoysiagrass (3.3%) and St. Augustinegrass (2.5%) were popular write-in choices which will be added in future surveys.

#### ***Factors limiting adoption of best management practices***

Survey results showed that the single most common factor which limits the ability of the survey respondents to adopt best management practices is cost or financial limitations (61.2%). About a third of the respondents also chose time and employee skill level (37.9% and 33.8%, respectively) as important limitations. The latter is interesting given how, when asked specifically about the difficulty of eight best management practices (see below), the average response was only about 3 on a scale of 1 to 5, with 5 being very difficult. It should be noted that less than 10% of the respondents considered BMPs not to be important, something which is also reflected when they rated the eight best management practices in terms of importance; the average rating was about 4 on a scale of 1 to 5, with 5 being very important.

#### ***Perceptions and commitment to best management practices as related to job categories***

The survey forms were analyzed in order to assess the target audience's perceptions and commitment to eight best management practices: (1) water conservation (ET<sub>o</sub>-based water budgets, seasonal adjustments of irrigation clocks, irrigation system checks, etc.); (2) fertility program development (fertilization based on plant species, type of use, seasonal and climatic requirements, and soil type; use of appropriate fertilizer type, amount and frequency of application); (3) turfgrass selection (choosing species and cultivars that, for example, require less water, possess more tolerance to stress [including pests] or possess other traits that would result in the successful management of turfgrass); (4) mowing program development (mowing height/frequency based on species/cultivar requirements, plant growth and/or stress, etc.); (5) integrated pest management (IPM) (managing the "most healthy" turfgrass as possible via sound agronomic principles as the best prevention to pests, defining threshold pest activity/amount prior to pesticide applications, etc.); (6) protecting ground water and surface water from potential contamination from turfgrass chemicals and fertilizers; (7) protecting non-target plants, animals and humans from the potential toxic effects of turfgrass chemicals; and (8) protecting native habitats during turfgrass construction and maintenance. The survey respondents were asked to rate these best management practices on a 1 to 5 scale in terms of importance (1 = not important and 5 = very important), whether or not they were doing the practice currently (1 = never doing it and 5 = always doing it), whether or not they would be likely to continue or to start doing the practice (1 = not likely and 5 = very likely), and in terms of the practice's difficulty level (1 = easy and 5 = very hard). When considered over all job classifications, the responses showed that the BMPs were considered to be important (the average for each job category ranged from 3.9 to 4.5), that they generally are conducting these practices (averages ranged from 3.4 to 4.1), that they are generally planning to continue or to start these practices (averages ranged from 3.6 to 4.3) and that these practices are only moderately difficult to implement (2.8 to 3.3).

In order to facilitate statistical analysis, the responses were grouped into two categories: "high" (with responses 4 or 5) and "low/moderate" (with responses 1, 2 or 3). The responses were then analyzed in terms of how they were affected by two different groupings of job categories: advisory vs. management and managers of general- vs. special-use turfgrass. The advisory category included those involved with the manufacture or sales of turfgrass-related products (fertilizers, mowers, irrigation equipment, etc.), professional consultants and horticulture advisors, and researchers. The management category included golf course and sports turf



managers, seed and turfgrass producers, professional residential lawn care specialists, and commercial and government site managers. The managers were then also divided into those managing general-use turfgrass (professional residential lawn care specialists, commercial and government site managers) and special-use turfgrass (golf course and sports turf managers and seed and turfgrass producers). Using the chi-square statistic, each of the two sets of groupings of job categories were analyzed in terms of their impact on the "high" or "low/moderate" response groups.

The results of the analysis of the advisory vs. management job categories on the response groupings showed that there was very little difference between the two groupings, with one particularly notable exception: mowing program development. Dramatically fewer in the advisory category considered mowing program development to be highly important (53% compared to 84% of managers), to be currently always or almost always using mowing programs (31% compared to 67% of managers), or highly likely to continue or to start developing mowing programs (37% compared to 68% of managers). The two groups, however, did agree that developing mowing programs is not particularly difficult (only 28% in the advisory category and 23% of the managers considered this practice to be highly difficult).

There were, however, numerous differences in the responses of managers in the general- vs. special-use job categories. Overall, whenever there were statistically significant differences between the two groupings, more of the special-use turfgrass managers than the general-use managers indicated a particular best management practice was highly important, that they were always or almost always conducting the practice, and that they were highly likely to continue or to start the practice. There were no differences between the two groups when it came to the difficulty level for any of the practices, however.

#### ***Audience feedback***

The vast majority of the respondents indicated that the information presented regarding BMPs was useful (93.4%), including 52.4% indicated it was somewhat useful, and 41.0% indicated it was very useful., the majority answered that the information was somewhat useful (52.4%). Only 3.5% of the respondents considered the information to not be useful, while 3.1% weren't sure.

The vast majority respondents may have considered the BMP information useful, but not all of them considered such information likely to result in the adoption or change in their irrigation or fertilization practices. Most were open to such change, with 52.9% indicating they were somewhat likely and 22.9% very likely to alter their practices based on the BMP information presented to them. However, as many as 1 in 5 respondents (20.6%) indicated that they were not likely to do so (another 3.6% indicated they were not sure).

**Table 1. 1998 protocol for irrigation treatments based on a percentage of historical (hist.) ET<sub>o</sub> (three treatments) and ET<sub>o</sub> (real time) (one treatment) for four, quarterly (3-month) periods, and three N-fertility treatments based on the annual N-fertility rate.**

Month	Monthly Historical ET <sub>o</sub> (inch) <sup>z</sup>	Quarter	Quarterly Historical ET <sub>o</sub> (inch) <sup>z</sup>	Irrigation treatment <sup>y</sup>				N-fertility treatment <sup>x</sup>					
				A	B	C	D	Date of application	Source of N	Rate (lb N/1000 ft <sup>2</sup> )			
										a	b	c	
Jan.	2.07	1											
Feb.	2.87	1	8.97	80% hist. ET <sub>o</sub> (7.18 inch)	58% hist. ET <sub>o</sub> (5.20 inch)	58% hist. ET <sub>o</sub> (5.20 inch)	80% ET <sub>o</sub>	March 1	CaNO <sub>3</sub>	0.75	1.125	1.50	
March	4.03	1											
April	4.13	2											
May	6.10	2	17.32	80% hist. ET <sub>o</sub> (13.86 inch)	90% hist. ET <sub>o</sub> (15.59 inch)	96% hist. ET <sub>o</sub> (16.63 inch)	80% ET <sub>o</sub>	May 15	NH <sub>4</sub> NO <sub>3</sub>	0.75	1.125	1.50	
June	7.09	2											
July	7.93	3											
Aug.	7.57	3	21.64	80% hist. ET <sub>o</sub> (17.31 inch)	90% hist. ET <sub>o</sub> (19.48 inch)	85% hist. ET <sub>o</sub> (18.39 inch)	80% ET <sub>o</sub>	August 15	NH <sub>4</sub> NO <sub>3</sub>	0.75	1.125	1.50	
Sept.	6.14	3											
Oct.	4.15	4											
Nov.	2.60	4	8.70	80% hist. ET <sub>o</sub> (6.96 inch)	58% hist. ET <sub>o</sub> (5.05 inch)	58% hist. ET <sub>o</sub> (5.05 inch)	80% ET <sub>o</sub>	October 15	CaNO <sub>3</sub>	0.75	1.125	1.50	
Dec.	1.75	4											
Total	56.63		56.63	45.31 inch	45.32 inch	45.27 inch	TBD <sup>w</sup>			3.0	4.5	6.0	

<sup>z</sup> Goldhamer, D. A. and R. L. Snyder. 1989. Irrigation scheduling: A guide for efficient on-farm water management. Univ. of California, Division of Agricultural and Natural Resources. Publication 21454 (see page 62). Data is for Riverside, CA.

<sup>y</sup> The CDFA study is a split-plot design, with irrigation treatments assigned to 20.0- x 20.0-ft main plots that are arranged in three randomized complete blocks (Fig. 1, page 40). Treatments A, B, and C reflect reported monthly turfgrass crop coefficients and are applied in two irrigation events per week—Saturday and Wednesday morning before sunrise. These treatments are based on the 3-month irrigation treatment quantity and scheduled utilizing the application rates of each main plot and the total number of irrigation events per quarter (irrigation run times are set the first day of each 3-month period). Treatment D is based on the previous 7-day cumulative ET<sub>o</sub> (from an on-site CIMIS station 169 ft from the center of the research plot) and is applied in two irrigation events per week—Saturday and Wednesday morning before sunrise. This treatment is scheduled utilizing the application rates of each main plot and the two irrigation events per week (irrigation run times are set on Tuesdays). Irrigation events for all treatments are cycled to prevent runoff. Rain is not subtracted from either the 3-month or weekly irrigation treatment quantity but may result in cancellation of an irrigation event.

<sup>x</sup> N-fertility treatments applied uniformly to subplots by hand application. Note that N fertility of the Jaguar III tall fescue (Fig. 1, page 40) follows the "b" N-fertility treatment and is applied using a calibrated drop spreader. P<sub>2</sub>O<sub>5</sub> and K<sub>2</sub>O applied as needed, according to annual soil test in December. Note: irrigation used to water in fertilizer will be subtracted from irrigation treatments.

<sup>w</sup> TBD = to be determined.

Table 2. 1999-2000 protocol for irrigation treatments based on a percentage of historical (hist.) ET<sub>o</sub> (three treatments) and ET<sub>o</sub> (real time) (one treatment) for four, quarterly (3-month) periods and three N-fertility treatments based on the annual N-fertility rate.

Month (Quarter)	Monthly historical ET <sub>o</sub> (inch) <sup>z</sup>	Monthly historical rain- fall (inch) <sup>y</sup>	Quarterly historical ET <sub>o</sub> & (hist. rain) (inch)	Irrigation treatment <sup>x</sup>				N-fertility treatment <sup>w</sup>				
				A	B	C	D	Date of application	Source of N N-P <sub>2</sub> O <sub>5</sub> -K <sub>2</sub> O	Rate (lb N/1000 ft <sup>2</sup> )		
										a	b	c
Jan (1)	2.07	1.85	8.97	80% hist. ET <sub>o</sub>	40% hist. ET <sub>o</sub>	40% hist. ET <sub>o</sub>	80% ET <sub>o</sub>	March 1	Polyon 43-0-0	1.0	1.5	2.0
Feb (1)	2.87	2.05	(5.55)	(7.18 inch)	(3.59 inch)	(3.59 inch)						
Mar (1)	4.03	1.65										
Apr (2)	4.13	1.02	17.32	80% hist. ET <sub>o</sub>	92% hist. ET <sub>o</sub>	85% hist. ET <sub>o</sub>	80% ET <sub>o</sub>	May 15	Polyon 42-0-0	1.0	1.5	2.0
May (2)	6.10	0.28	(1.34)	(13.86 inch)	(15.93 inch)	(14.72 inch)						
Jun (2)	7.09	0.04										
Jul (3)	7.93	0.00	21.64	80% hist. ET <sub>o</sub>	91% hist. ET <sub>o</sub>	97% hist. ET <sub>o</sub>	80% ET <sub>o</sub>	August 15	Polyon 42-0-0	1.0	1.5	2.0
Aug (3)	7.57	0.12	(0.32)	(17.31 inch)	(19.69 inch)	(20.99 inch)						
Sep (3)	6.14	0.20										
Oct (4)	4.15	0.39	8.70	80% hist. ET <sub>o</sub>	70% hist. ET <sub>o</sub>	70% hist. ET <sub>o</sub>	80% ET <sub>o</sub>	October 15	Polyon 43-0-0	1.0	1.5	2.0
Nov (4)	2.60	1.02	(3.22)	(6.96 inch)	(6.09 inch)	(6.09 inch)						
Dec (4)	1.75	1.81										
Total	56.63	10.43	56.63 (10.43)	45.31 inch	45.30 inch	45.39 inch	TBD <sup>v</sup>			4.0	6.0	8.0

<sup>z</sup> Goldhamer, D. A. and R. L. Snyder. 1989. Irrigation scheduling: A guide for efficient on-farm water management. Univ. of California, Division of Agricultural and Natural Resources. Publication 21454 (see page 62). Data is for Riverside, CA.

<sup>y</sup> Anonymous. 1981. California rainfall summary, monthly total precipitation, 1949-1980. SDWR. 54 pp. plus microfiche. Data is for Riverside, CA.

<sup>x</sup> The CDFA study is a split-plot design, with irrigation treatments assigned to 20.0- x 20.0-ft main plots that are arranged in three randomized complete blocks. Treatments A, B, and C reflect reported monthly turfgrass crop coefficients and are applied in two irrigation events per week—Saturday and Wednesday morning before sunrise. These treatments are based on the 3-month irrigation treatment quantity and scheduled utilizing the application rates of each main plot and the total number of irrigation events per quarter (irrigation run times are set the first day of each 3-month period). Treatment D is based on the previous 7-day cumulative ET<sub>o</sub> (from an on-site CIMIS station 169 ft from the center of the research plot) and are applied in two irrigation events per week—Saturday and Wednesday morning before sunrise. This treatment is scheduled utilizing the application rates of each main plot and the two irrigation events per week (irrigation run times are set on Tuesdays). Irrigation events for all treatments are cycled to prevent runoff. Rain is not subtracted from either the 3-month or weekly irrigation treatment quantity but may result in cancellation of an irrigation event.

<sup>w</sup> N-fertility treatments applied uniformly to subplots by hand application. Note that N fertility of the Jaguar III tall fescue (Fig. 1, page 40) will follow the "b" N-fertility treatment and is applied using a calibrated drop spreader. P<sub>2</sub>O<sub>5</sub> applied as needed, according to annual soil test in December. K<sub>2</sub>O applied in April, May, June, November and December at the rate of 1.2 lb K<sub>2</sub>O/1000 ft<sup>2</sup> per application (for a total of 6.0 lb K<sub>2</sub>O applied during the year). Note: irrigation used to water in fertilizer will be subtracted from irrigation treatments.

<sup>v</sup> TBD = to be determined.

**Table 3. Summary of ET<sub>o</sub> and historical ET<sub>o</sub>, rainfall, and applied irrigation water for 1998, Riverside, CA.**

Variable	Quarter																Annual			
	January to March				April to June				July to September				October to December				January to December			
	Irrigation treatment (% quarterly ET <sub>o</sub> )				Irrigation treatment (% quarterly ET <sub>o</sub> )				Irrigation treatment (% quarterly ET <sub>o</sub> )				Irrigation treatment (% quarterly ET <sub>o</sub> )				Irrigation treatment (% quarterly ET <sub>o</sub> )			
	A (80% hist. ET <sub>o</sub> ) <sup>z</sup>	B (58% hist. ET <sub>o</sub> )	C (58% hist. ET <sub>o</sub> )	D (80% ET <sub>o</sub> ) <sup>y</sup>	A (80% hist. ET <sub>o</sub> ) <sup>z</sup>	B (90% hist. ET <sub>o</sub> )	C (96% hist. ET <sub>o</sub> )	D (80% ET <sub>o</sub> ) <sup>y</sup>	A (80% hist. ET <sub>o</sub> ) <sup>z</sup>	B (90% hist. ET <sub>o</sub> )	C (85% hist. ET <sub>o</sub> )	D (80% ET <sub>o</sub> ) <sup>y</sup>	A (80% hist. ET <sub>o</sub> ) <sup>z</sup>	B (58% hist. ET <sub>o</sub> )	C (58% hist. ET <sub>o</sub> )	D (80% ET <sub>o</sub> ) <sup>y</sup>	A (80,80, 80, 80% hist. ET <sub>o</sub> ) <sup>z</sup>	B (58,90, 90, 58% hist. ET <sub>o</sub> )	C (58,96, 85, 58% hist. ET <sub>o</sub> )	D (80,80, 80, 80% ET <sub>o</sub> ) <sup>y</sup>
ET <sub>o</sub> (mm)	195.2	195.2	195.2	195.2	418.0	418.0	418.0	418.0	512.7	512.7	512.7	512.7	244.7	244.7	244.7	244.7	1371	1371	1371	1371
Historical ET <sub>o</sub> (mm)	227.8	227.8	227.8	227.8	439.9	439.9	439.9	439.9	549.6	549.6	549.6	549.6	221.0	221.0	221.0	221.0	1438	1438	1438	1438
ET <sub>crop</sub> (ET <sub>o</sub> x K <sub>c</sub> month) (mm)	133.9	133.9	133.9	133.9	398.5	398.5	398.5	398.5	440.7	440.7	440.7	440.7	169.0	169.0	169.0	169.0	1142	1142	1142	1142
Rainfall (mm)	366	366	366	366	43	43	43	43	14	14	14	14	24	24	24	24	447	447	447	447
Historical rainfall (mm) <sup>x</sup>	141	141	141	141	34	34	34	34	8	8	8	8	82	82	82	82	265	265	265	265
Applied water (mm) <sup>w</sup>	53	60	60	66	296	336	358	219	444	497	466	433	178	128	131	201	971	1021	1015	919
Total water (rainfall plus applied) (mm)	419	426	426	432	339	379	401	262	458	511	480	447	202	152	155	225	1418	1468	1462	1366
(Applied water/ET <sub>crop</sub> ) x 100	39.6	44.8	44.8	49.3	74.3	84.3	89.8	55.0	100.7	112.8	105.7	98.3	105.3	75.7	77.5	119.1	85.0	89.4	88.9	80.5
(Applied water/ET <sub>o</sub> ) x 100	27.2	30.7	30.7	<u>33.8</u>	70.8	80.4	85.6	<u>52.4</u>	86.6	96.9	90.9	<u>84.5</u>	72.7	52.3	53.5	<u>82.2</u>	70.8	74.5	74.0	67.0
(Applied water/historical ET <sub>o</sub> ) x 100	<u>23.3</u>	<u>26.3</u>	<u>26.3</u>	29.0	<u>67.3</u>	<u>76.4</u>	<u>81.4</u>	49.8	<u>80.8</u>	<u>90.4</u>	<u>84.8</u>	81.0	<u>80.5</u>	<u>57.9</u>	<u>59.3</u>	93.2	67.5	71.0	70.6	63.9
No. irrigation events	10	10	10	10	22	22	22	19	27	27	27	27	26	26	26	26	85	85	85	82
No. irrigation events canceled	16	16	16	16	4	4	4	7	0	0	0	0	0	0	0	0	20	20	20	23

<sup>z</sup>Historical ET<sub>o</sub>. Goldhamer, D. A. and R. L. Snyder. 1989. Irrigation scheduling: A guide for efficient on-farm water management. Univ. of California, Division of Agricultural and Natural Resources. Publication 21454 (see p.62).

<sup>y</sup>Real-time ET<sub>o</sub> based on 7-day cumulative ET<sub>o</sub> from an on-site CIMIS station 169 ft from the center of the research plot.

<sup>x</sup>Anonymous. 1981. California summary, monthly total precipitation, 1949-1980. SDWR. 54 pp. plus microfiche.

<sup>w</sup>Applied water is calculated as (actual water time per day / system precipitation rate) x no. irrigation events. Numbers for each irrigation treatment are calculated as the average of three replicate plots.

Note: Within each column, underlined percentages can be compared to the percentages that are listed directly below the letters (A, B, C, D) that designate irrigation treatments.

## **ISSUES RELATED TO RECYCLED WATER FOR TURF USE**

**Marylynn V. Yates**

*Dept. of Environmental Sciences, University of California, Riverside, CA 92521-0124*

As competition for the increasingly scarce fresh water resources have intensified, the use of recycled water for non-potable purposes such as irrigation has increased. In California, the use of recycled water is regulated by the Department of Health Services under the Title 22 regulations. The focus of these regulations in the past has been on a few water quality measures such as total coliform bacteria, turbidity and total organic carbon. These constituents have been used as indicators of water quality; in other words, their presence implies the presence of potentially harmful contaminants and their absence implies the absence of those contaminants. However, it has become increasingly apparent in the last several years that these indicators may not be suitable. Many disease-causing microorganisms are more resistant to wastewater treatment than are total coliform bacteria; therefore, the absence of the total coliform bacteria does not guarantee that the water is free of pathogens. At this time, the regulations are under revision to require more extensive treatment of recycled water to remove pathogenic microorganisms. There are also increasing concerns over the presence of potentially carcinogenic chemicals that are produced during the disinfection of the wastewater. These concerns have led to a reconsideration of the use of total organic carbon as a measure of the quality of the recycled water. In addition to revision of the regulations in light of these concerns about human health hazards, the use of recycled water may be impacted by other regulations. For example, the U.S. Environmental Protection Agency is in the process of developing a drinking water regulation, the Ground Water Rule, to protect potable groundwater supplies from fecal contamination. Ground water wells that are deemed vulnerable to fecal contamination will have to be treated to remove potentially hazardous microorganisms. Sources of fecal contamination include recycled water. Depending on the specific site conditions, such as soil type, hydraulic properties, depth to ground water, etc., application of recycled water may result in contamination of the underlying ground water with microorganisms, especially viruses. In the future, consideration of the location of potable wells will have to be made when proposing to use recycled water for irrigation.

## URBAN WASTE-BASED SOIL AMENDMENTS – ARE THEY FOR HORTICULTURAL USES?

**Andrew C. Chang**

*Dept. of Environmental Sciences; University of California, Riverside, CA 92521-0424*

In California, large amounts of organic solid wastes are generated each year. With the enactment of AB 939 (California Solid Waste Reduction Act) in 1989, increasingly greater amounts of the green wastes are being separated from the urban solid waste stream, diverted from landfills, and processed into stable organic matter awaiting beneficial uses. These products from urban wastes are aimed primarily at the soil amendments market in landscaping, horticulture, and crop productions.

Organic amendments may be incorporated into the soil as conditioner of soil properties, used as mulch, and used as an ingredient in potting mixes. For the past 70 years, the benefits of using organic amendments have been demonstrated. When the organic amendments are incorporated into the soil, they altered the physical properties of soils to make the soils more cultivatable. Reitemeier and Christiansen (1948) showed that organic soil amendments were effective in improve the infiltration rate of low total salts and high sodium absorption ratio water through a sandy soil (Table 1).

**Table 1. Effects of Organic Soil Amendments on Infiltration of Low Total Salt and High SAR Water Through A Sandy Soil (Reitemeier et al., 1948).**

Amendment Treatment <sup>+</sup>	Infiltration rate (Inches per Hour)			
	1 <sup>st</sup> Inch of Water	2 <sup>nd</sup> Inch of Water	3 <sup>rd</sup> Inch of Water	4 <sup>th</sup> Inch of Water
Control	0.36	0.16	0.11	0.11
Organic	0.74	0.31	0.24	0.20
Gypsum	0.69	0.36	0.27	0.27

<sup>+</sup>Amendments added at 10 tons per acre.

The organic material in the soil significantly increased the micro- and macroporosity of the soils (Pagliai and Vittori Antisari, 1993). As a result, the bulk density, hydraulic conductivity, water holding capacity, and modulus of rupture of the treated soils became more conducive for cultivation (Table 2)

**Table 2. Physical Properties of Composted Sewage Sludge-treated Domino Silty Loam (Chang et al., 1983).**

Treatment <sup>+</sup>	Bulk Density (g cm <sup>-3</sup> )	H <sub>2</sub> O Holding Capacity (%)	Permeability (cm hr <sup>-1</sup> )	Modulus of Rupture (kg cm <sup>-2</sup> )
Control	1.45	23	0.1	3.20
22.5 (Mg ha <sup>-1</sup> yr <sup>-1</sup> )	1.28	24	2.2	1.10
45.0 (Mg ha <sup>-1</sup> yr <sup>-1</sup> )	1.18	26	5.4	0.8
90.0 (Mg ha <sup>-1</sup> yr <sup>-1</sup> )	1.09	27	5.7	0.4

<sup>+</sup>4 years of consecutive treatments.

The improvements were proportional to the amounts and duration of the treatment.

When the organic amendments are used as mulch. They enhance the aesthetics value of the landscape, preserve the soil moisture, modulate soil temperature, prevent soil erosion, and suppress weed infestation. Bushnell and Welton (1931) showed that mulch, when used properly, lowered the soil temperature in the summer, conserved soil moisture, and improved plant performance (Table 3).

**Table 3. Effects of Mulch in Plant Growth (Bushnell and Welton, 1931).**

Treatment	Soil Temperature (°F)		Water Content of Soil (%)		Plant Performance <sup>+</sup>
	Average	Maximum	Average	Range	
Mulched	63	68	18	16 - 20	275
Un-mulched	69	>90	13	9 - 16	136

<sup>+</sup>Yield of Russet potato (bushels per acre) at Wooster, Ohio, 1925.

In general, a large amount of organic amendments are needed in formulate soil mix for container growth of plants. Richards et al. (1964) determined the physical properties of organic amendment-formulated soil mixes (Table 4).

**Table 4. Effects of Organic Amendments on Physical Properties of Soil Mixes (Richards et al., 1964)**

Treatment	Bulk Density (g cm <sup>-3</sup> )	Permeability (cm hr <sup>-1</sup> )	Water Release (cm cm <sup>-1</sup> )
Control	1.36	0.5	0.15
Wood Shavings @ 30%	1.14	2.5	0.21
Wood Shavings @ 60%	0.87	10	0.26
Peat @ 30%	1.09	0.6	0.21
Peat @ 60%	0.79	3.8	0.34

Other waste-derived material produced similar results (Chang et al. 1977; Chang et al., 1983). For practical purpose, they may be used interchangeably in prepare potting mixes.

More than 50% of the nation's population are living in the states that have enacted regulations to separate green wastes from the municipal solid waste stream. As the urban market for soil amendments is already filled with product derived from barks, wood chips and shavings, sawdust, animal manure, etc. Are there rooms for additional organic amendments produced from municipal wastes?

As urban waste-based soil organic amendments are derived from wastes of various origins, the quality of the products is difficult to control and its composition may vary from one shipment to another. Under this circumstance, it will be difficult for urban-waste derived organic amendments to compete with the established products. The answer lies on the standardizing the products. A standard specifies the minimum quality requirements for a material or product to perform its intended function. The standardization, when adopted industry-wide, sets the product quality expectation for producers and insures the user consistency in product performance. The standardization allows the urban waste-derived products, if produced according to specifications, to become main stream.

It is time that the industry take the initiative to develop a technical specification for soil amendments that may be used a guide in classification and selection of products.

## **References**

- Chang, A. C., L. J. Lund, A. L. Page, and J. E. Warneke. 1977. Physical Properties of Fly Ash-amended soils. *J. Environ. Qual.* 6:267-270.
- Chang, A. C., A. L. Page, and J. E. Warneke. 1983. Soil Conditioning Effects of Municipal Sludge Compost. *J. Environ. Engr.* 109:574-583.
- Bushnell, J. and F. A. Welton. 1931. Some Effects of Straw Mulch on Yield of Potatoes. *J. Agr. Res.* 43:837-845.
- Pagliai, M. and L/ Vittori Antisari. 1993. Influence of Waste Organic Matter on Soil Micro- and Macrostructure. *Bioresource Technology* 43:205-213.
- Reitemeier, R. F., J. E. Christiansen, R. E. Moore, W. W. Aldrich. 1948. Effect of Gypsum, Organic Matter, and Drying on Infiltration of A Sodium Water into A Fine Sand Loan. U.S. Department of Agriculture, Technical Bulletin No. 937. January 1948. 36pp.
- Richards, S. J., J. E. Warneke, A. W. Marsh, and F. K. Aljibury. 1964. Physical Properties of Soil Mixes. *Soil Sci.* 98:129-132.



## RETRACTABLE ROOF RESEARCH WRAPUP

Stephen T. Cockerham<sup>1</sup>, Steve B. Ries<sup>1</sup>, George H. Riechers<sup>1</sup>, and Victor A. Gibeault<sup>2</sup>

<sup>1</sup>Agricultural Operation, University of California, Riverside, CA 92521-0124

<sup>2</sup>Dept. of Botany and Plant Sciences, University of California, Riverside, CA 92521-0124

### RESEARCH OBJECTIVES FOR MAJOR LEAGUE RETRACTABLE ROOF BASEBALL STADIUM PLAYING FIELD

- Determine if it is possible to have natural grass
- Determine if it is possible to have natural grass for the full season
- Select a grass best suited for the conditions
- Determine cultural requirements of the turf
- Develop cultural technology needed
- Develop Best Management Practices

### CRITERIA FOR TURFGRASS PLAYING FIELD IN A MAJOR LEAGUE RETRACTABLE ROOF BASEBALL STADIUM

Major League quality turf

Last full season with only minor replacement for injury

Irradiance requirements to be determined

Max. 4.5 hrs. sun March

Max. 6.5 hrs. sun June

Take max. 8 consecutive days roof closure 2X per season

Roof could be opened every day if needed

Supplemental light as artificial or reflected

Grass to be heat, shade, and traffic tolerant

**Growth Chamber (73 °F) Kentucky bluegrass**

Treatment: 11.2, 2.2, 0.9 mols PPFD d<sup>-1</sup> @ 24 hrs d<sup>-1</sup>

Results: Yield significant 11.2 @ 29 d

**Perennial Ryegrass**

Treatment: 20.0, 11.1, 4.1 mols PPFD d<sup>-1</sup> @ 24 hrs d<sup>-1</sup>

Results: Total mass significant 20.0/11.1/0.9 @ 29 d

**'De Anza' zoysiagrass**

Treatment: 20.0, 11.1, 4.1 mols PPFD d<sup>-1</sup> @ 24 hrs d<sup>-1</sup>

Results: Total mass 20.0/11.1 similar sgn. high @ 42 d

**'De Anza' zoysiagrass Growth Chamber and Restricted light louvres**

Treatment: 20.0, 11.1, 4.1 mols PPFD d<sup>-1</sup> 14 d @ 24 hrs d<sup>-1</sup> for 14 d and 28 d to recover under restricted light louvres

Results: Yields recovery 14 and 28 d @ 20.0 and 14 d @ 11.1 similar

**Growth Chamber (86 °F) 'De Anza' zoysiagrass**

Treatment: 0.9, 2.2, 8.6 mols PPFD d<sup>-1</sup> @ 24 hrs d<sup>-1</sup>

Results: Increased growth @ 2.2 mols PPFD d<sup>-1</sup> @ 24 hrs d<sup>-1</sup>

**Light trolley Xenon 1000W 12 hrs d<sup>-1</sup> Kentucky bluegrass (pots)**

Treatments: 10.3, 8.2, 6.0, 4.3, 2.5 mols PPFD d<sup>-1</sup>

Results: 6.0 significantly high clippings

**Perennial ryegrass (pots)**

Treatments: 31.6, 20.0, 8.1 mols PPFD d<sup>-1</sup>

Results: 31.6 and 20.0 similar/significantly high total mass

**'DeAnza' zoysia (pots)**

Treatments: 10.3, 6.0, 2.5 mols PPFD d<sup>-1</sup>

Results: 10.3 total mass significant high 10.3 and 2.5 clippings significant high

**Light source 'DeAnza' zoysia (pots)**

Treatments: Xenon1000w (Xe), Sulfur microwave (Sm) high pressure sodium (hps) 14 mols PPFD d<sup>-1</sup> @ 4 hrs d<sup>-1</sup>

Results: 21 d significant hps/Sm/Xe. At 28 d no significant difference.

**Reflected light Ky. bluegrass and 'DeAnza' zoysiagrass**

Treatment: Poly tarp reflector provided 2 mols PPFD d<sup>-1</sup>

Mylar tarp reflector provided 5 mols PPFD d<sup>-1</sup>

Results: No difference in poly tarp. Mylar tarp 'DeAnza' zoysia response greater than Ky. bluegrass

**Air movement (27 d) Kentucky bluegrass**

Treatment: Wind speed 0.21, 0.76, 1.25 ms<sup>-1</sup>

Results: Acceptable @ 0.76 ms<sup>-1</sup>, unacceptable @ 0.21 ms<sup>-1</sup>

*Curvularia* spp. identified on injured turf in low wind speed

**Air movement (35 d) 'De Anza' zoysiagrass**

Treatment: Wind speed 0.06, 0.20, 0.33 ms<sup>-1</sup>

Results: No significant difference

**RESTRICTED LIGHT LOUVRES—POT STUDIES**

**Winter Rooting zoysia plugs November to January**

Treatment: Biostimulants, fertilizer, tarp

Results: Biostimulants No significant effect; fertilizer decrease; tarp increase

**Roof simulated closed (C) and open (O)**

	Zoysia Clippings	
	gm m <sup>-2</sup> d <sup>-1</sup>	% of high
3d C + 1d O	5.1	61
1d C + 1d O	7.1	85
3d C + 3d O	6.6	79
1d C + 3d O	8.2	98
Open	8.4	100
Full sun	5.2*	62

\*Drought injury

**Roof closed (C) zoysiagrass**

	<i>Clippings</i>		<i>Root mass</i>	
	<i>gm m<sup>-2</sup> d<sup>-1</sup></i>	<i>% of high</i>	<i>gm m<sup>-2</sup> d<sup>-1</sup></i>	<i>% of high</i>
12d C	4.3	53	68	83
9d C	4.6	57	74	90
6d C	5.6	69	79	96
Open	8.1	100	82	100

**RESTRICTED LIGHT LOUVRES—FIELD PLOT STUDIES**

**Tarp and PGR Zoysia Response**

Treatment: Vented tarp; Primo (trinexapac-methyl)

Results: Tarp-Turf Score midwinter; increase early spring decrease  
 Clippings spring increase; Root mass midwinter no effect  
 Primo-Turf Score spring increase; Clippings spring decrease  
 Root mass midwinter no effect

**Temperatures under vented tarp**

	<b>Feb. 19 ( °F)</b>			
	<b>9:30</b>	<b>10:15</b>	<b>2:15</b>	<b>4:15</b>
Full sun				
open 5 cm	52	59	67	66
tarp 5 cm	61	71	81	80
air under tarp	75	96	93	75
Restricted light louvres				
open sun 5 cm	54	58	66	--
shade 5 cm	52	56	66	63
tarp sun 5 cm	60	64	78	--
shade 5cm	58	63	78	70
air under tarp sun	76	94	90	--
shade	65	70	81	67

**Vented tarp sod response 'DeAnza' zoysiagrass Feb 13-Mar 21**

Treatment: Full sun sod tarped and not tarped after install  
 Full sun washed tarped and not tarped after install  
 Tarped before install in full sun tarped and not tarped after install  
 Louvred sod tarped and not tarped  
 Louvred sod washed tarped and not tarped

Results: Turf color, clip yields, root mass, sod displacement--Best not tarped before and tarped after install



## **TURFGRASS CULTIVAR EVALUATIONS: UC RIVERSIDE**

**Victor A. Gibeault and Richard Autio**

*Dept. of Botany and Plant Sciences, University of California, Riverside, CA 92521-0124*

The National Turfgrass Evaluation Program (NTEP) is a non-profit organization that provides leadership in turfgrass evaluation and improvement by linking the public and private sectors of the industry through their common goals of grass development, improvement, and evaluation. Its mission is to provide a mechanism for uniform evaluations; to advance the science of species and cultivar evaluation; to collect and disseminate performance information; and to enhance the transfer and use of information and technology relating to turfgrass improvement and evaluation. Structurally, NTEP is a cooperative effort of the United States Department of Agriculture (at Beltsville, MD) and the Turfgrass Federation, Inc.

The clientele of NTEP are diverse, with varying interests and expectations. To be clientele sensitive, NTEP has identified the following categories of interest groups that interact and benefit from the activities of the program: public and private turfgrass plant breeders; public and private sector researchers; seed distributors; technology transfer educators such as cooperative extension educators and industry technical representatives; other professionals such as seed producers, sod producers, golf course superintendents, grounds managers, sports turf managers, lawn care service operators, landscape contractors, landscape architects and consultants. Homeowners indirectly are influenced by NTEP because the turfgrasses they buy have been tested for performance characteristics in their climate zones.

Most cultivar evaluations are conducted by university turfgrass research and extension programs, but modified studies by private plant breeders are also undertaken. Seed or vegetative material of a turfgrass species is accumulated by the program and sent to cooperating researchers where replicated trials are established. Somewhat standardized establishment and cultural practices are used and they are reported for each site. Data collected on a monthly basis during the growing season are also standardized and usually include a turfgrass quality rating.

Other specific characteristics such as color, texture, spring green-up, density, drought tolerance and disease or weed activity are rated when appropriate. Data are sent to NTEP on an annual basis, statistical analyses performed and annual results are reported by species. Those reports are used as a basis for information transfer to interested clientele.

Four NTEP studies are currently underway at UCR. The plot plans follow, as do national results for the 1998 calendar year for three of the grasses under examination.

1996 NTEP BUFFALOGRASS TEST  
Est. 29 July 1996

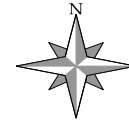

5	3	2	1	4	10	9
13	6	11	14	8	7	12
1	2	3	5	4	13	10
14	11	8	7	12	9	6
4	1	5	2	3	11	8
10	9	12	6	13	7	14

Seeded

1. CODY
2. TATANKA
3. BAM-1000
4. BISON
5. TEXOKA

Vegetative

6. 91-118
7. 86-120
8. 86-61
9. BONNIE BRAE
10. MIDGET
11. STAMPEDE
12. UC-95
13. 609
14. 378

*Proceedings of the UCR Turfgrass and Landscape Management Research Conference and Field Day, September 1999*

TABLE 1A. MEAN TURFGRASS QUALITY RATINGS OF BUFFALOGRASS CULTIVARS  
GROWN AT ELEVEN LOCATIONS IN THE U.S. 1/  
1998 DATA

TURFGRASS QUALITY RATINGS 1-9; 9=IDEAL TURF 2/

NAME	AZ1	CA3	FL3	GA1	MO1	NE1	SC2	TX1	TX3	VA1	WA4	MEAN
91-118	5.4	5.0	7.4	6.2	7.1	7.1	7.2	6.0	6.7	3.3	3.8	5.9
* LEGACY (86-61)	5.3	4.2	6.5	5.2	7.0	7.1	7.3	5.2	6.4	3.0	4.6	5.6
* CODY 86-120	4.9	4.4	6.8	5.6	6.2	6.0	6.4	4.6	7.0	4.0	5.2	5.6
* TATANKA	5.1	4.2	6.5	5.3	6.9	6.6	7.3	5.3	6.4	2.4	4.5	5.5
* BONNIE BRAE	5.0	4.3	6.2	5.5	6.5	6.0	6.5	4.3	7.0	4.0	4.9	5.5
* BAM-1000	5.0	4.4	6.4	5.1	6.2	6.8	6.7	5.7	6.5	3.0	3.8	5.4
* 378	5.2	4.1	5.5	5.5	6.7	5.3	6.5	4.5	7.1	3.9	4.8	5.4
* TEXOKA	5.1	4.3	5.4	5.3	7.0	7.0	6.9	4.7	6.3	2.4	4.3	5.3
* MIDGET	5.2	4.2	5.7	5.6	6.7	4.9	6.4	4.6	7.4	3.7	4.0	5.3
* BISON	4.7	4.4	5.4	4.9	6.7	6.1	6.4	4.6	7.3	3.3	3.8	5.2
* 609	5.3	4.3	4.6	5.2	6.4	5.3	6.3	4.2	7.4	2.9	3.9	5.1
* STAMPEDE	5.9	4.4	6.8	5.8	5.4	1.4	6.5	5.8	7.4	2.3	3.8	5.1
UCR-95	5.6	4.5	6.8	5.7	5.6	2.4	5.7	5.7	6.8	2.2	4.3	5.0
UCR-95	5.0	5.2	5.5	5.7	4.5	1.0	6.8	5.7	7.4	2.6	3.3	4.8
LSD VALUE	0.4	0.4	1.2	0.5	1.1	0.9	1.3	0.7	0.4	0.7	1.2	0.3
C.V. (%)	5.1	5.3	12.1	5.7	11.0	11.2	12.2	8.1	3.6	14.9	17.4	10.2

\* COMMERCIALY AVAILABLE IN THE USA IN 1999.

1/ TO DETERMINE STATISTICAL DIFFERENCES AMONG ENTRIES, SUBTRACT ONE ENTRY'S MEAN FROM ANOTHER ENTRY'S MEAN. STATISTICAL DIFFERENCES OCCUR WHEN THIS VALUE IS LARGER THAN THE CORRESPONDING LSD VALUE (LSD 0.05).

2/ C.V. (COEFFICIENT OF VARIATION) INDICATES THE PERCENT VARIATION OF THE MEAN IN EACH COLUMN.

**Proceedings of the UCR Turfgrass and Landscape Management Research Conference and Field Day, September 1999**

TABLE 1B. MEAN TURFGRASS QUALITY RATINGS OF BUFFALOGRASS (SEEDED) CULTIVARS  
GROWN AT ELEVEN LOCATIONS IN THE U.S. 1/  
1998 DATA

NAME	TURFGRASS QUALITY RATINGS 1-9; 9=IDEAL TURF 2/											
	AZ1	CA3	FL3	GA1	MO1	NE1	SC2	TX1	TX3	VA1	WA4	MEAN
CODY	4.9	4.4	6.8	5.6	6.2	6.0	6.4	4.6	7.0	4.0	5.2	5.6
TATANKA	5.0	4.3	6.2	5.5	6.5	6.0	6.5	4.3	7.0	4.0	4.9	5.5
BAM-1000	5.2	4.1	5.5	5.5	6.7	5.3	6.5	4.5	7.1	3.9	4.8	5.4
TEXOKA	5.2	4.2	5.7	5.6	6.7	4.9	6.4	4.6	7.4	3.7	4.0	5.3
BISON	5.3	4.3	4.6	5.2	6.4	5.3	6.3	4.2	7.4	2.9	3.9	5.1
LSD VALUE	0.3	0.4	1.1	0.6	0.9	0.4	0.8	0.5	0.4	0.9	0.8	0.2
C.V. (%)	3.6	5.4	11.8	6.4	8.3	4.4	7.6	7.5	3.6	14.8	11.1	7.9

TABLE 1C. MEAN TURFGRASS QUALITY RATINGS OF BUFFALOGRASS (VEGETATIVE) CULTIVARS  
GROWN AT ELEVEN LOCATIONS IN THE U.S. 1/  
1998 DATA

NAME	TURFGRASS QUALITY RATINGS 1-9; 9=IDEAL TURF 2/											
	AZ1	CA3	FL3	GA1	MO1	NE1	SC2	TX1	TX3	VA1	WA4	MEAN
91-118	5.4	5.0	7.4	6.2	7.1	7.1	7.2	6.0	6.7	3.3	3.8	5.9
LEGACY (86-61)	5.3	4.2	6.5	5.2	7.0	7.1	7.3	5.2	6.4	3.0	4.6	5.6
86-120	5.1	4.2	6.5	5.3	6.9	6.6	7.3	5.3	6.4	2.4	4.5	5.5
BONNIE BRAE	5.0	4.4	6.4	5.1	6.2	6.8	6.7	5.7	6.5	3.0	3.8	5.4
378	5.1	4.3	5.4	5.3	7.0	7.0	6.9	4.7	6.3	2.4	4.3	5.3
MIDGET	4.7	4.4	5.4	4.9	6.7	6.1	6.4	4.6	7.3	3.3	3.8	5.2
609	5.9	4.4	6.8	5.8	5.4	1.4	6.5	5.8	7.4	2.3	3.8	5.1
STAMPEDE	5.6	4.5	6.8	5.7	5.6	2.4	5.7	5.7	6.8	2.2	4.3	5.0
UCR-95	5.0	5.2	5.5	5.7	4.5	1.0	6.8	5.7	7.4	2.6	3.3	4.8
LSD VALUE	0.5	0.4	1.2	0.5	1.3	1.1	1.5	0.7	0.4	0.7	1.3	0.3
C.V. (%)	5.7	5.3	12.2	5.3	12.4	14.0	13.9	8.3	3.7	14.8	20.7	11.2

1/ TO DETERMINE STATISTICAL DIFFERENCES AMONG ENTRIES, SUBTRACT ONE ENTRY'S MEAN FROM ANOTHER ENTRY'S MEAN. STATISTICAL DIFFERENCES OCCUR WHEN THIS VALUE IS LARGER THAN THE CORRESPONDING LSD VALUE (LSD 0.05).

2/ C.V. (COEFFICIENT OF VARIATION) INDICATES THE PERCENT VARIATION OF THE MEAN IN EACH COLUMN.



## 1997 NTEP BERMUDAGRASS TRIAL established 30 June 1997



Varieties 1-18 and 29 are seeded, 19-28 are vegetative

29	4	5	1	6	11	17	18
14	13	3	12	8	7	2	9
17	7	4	15	18	10	16	15
8	2	11	14	9	5	13	29
1	4	6	10	16	3	1	12
3	12	15	13	8	18	14	11
6	29	9	17	16	2	7	10
X	X	X	X	X	X	X	5
22	27	26	23	24	28	X	X
25	20	19	21	20	27	22	25
19	21	23	28	24	26	19	21
24	27	26	22	20	25	28	23

1 Savannah  
2 2PST-R69C  
3 Princess  
4 SW 1-7  
5 SW 1-11  
6 Jackpot  
7 Sundevil II  
8 J-540  
9 J-1224

10 Shangri La  
11 Mirage  
12 Pyramid  
13 Majestic  
14 OKS 95-1  
15 Blue-Muda  
16 Blackjack  
17 Sahara  
18 AZ Common

19 Mini-Verde  
20 Shanghai  
21 CN 2-9  
22 OKC 18-4  
23 OKC 19-9  
24 Cardinal  
25 Tift 94  
26 Midlawn  
27 Tifway

28 Tifgreen  
29 Panama

TABLE 1A.

MEAN TURFGRASS QUALITY RATINGS OF BERMUDAGRASS CULTIVARS  
GROWN AT NINETEEN LOCATIONS IN THE U.S. 1/  
1998 DATA

TURFGRASS QUALITY RATINGS 1-9; 9=IDEAL TURF 2/

NAME	AR1	AZ1	CA3	FL1	GA1	IL2	IN2	KS2	KY1	MO1	MO2	MO3	MS1	NM1	OK1	SC2	TX2	VA1	VA4	MEAN
OKS 95-1	6.8	6.3	5.3	5.3	6.3	7.1	6.1	6.7	7.9	8.1	6.7	7.7	5.5	7.5	6.9	7.0	5.7	5.4	6.5	6.6
OKC 18-4	7.2	6.0	5.2	5.6	7.4	6.7	6.7	6.6	6.4	7.8	6.5	7.3	6.3	7.5	6.7	7.5	5.8	5.6	6.1	6.6
* TIFGREEN	6.9	5.5	5.9	5.5	6.9	7.0	6.2	5.7	7.2	8.0	5.9	7.0	6.9	7.2	6.5	7.3	6.2	5.1	6.6	6.5
* TIFWAY	6.6	5.9	5.7	6.0	7.1	6.5	5.9	6.6	7.9	7.4	5.7	6.8	7.3	7.2	6.0	8.1	5.4	3.8	6.6	6.5
* MIDLAWN	7.1	5.6	5.4	4.1	6.9	7.4	6.2	7.1	6.4	7.1	6.5	7.5	6.2	7.6	5.9	7.2	5.4	4.9	6.4	6.4
* PRINCESS	6.9	6.6	5.2	5.7	6.8	5.5	5.8	6.1	7.6	6.6	5.1	7.1	6.0	7.6	6.6	6.9	6.3	6.0	6.3	6.4
* TIFSPORT (TIFT 94)	6.9	6.1	5.7	5.9	6.9	6.7	5.8	5.6	7.9	6.8	4.4	6.2	7.3	7.3	6.1	7.7	5.5	3.8	6.7	6.3
CN 2-9	6.4	5.8	5.4	5.2	6.8	6.1	5.7	6.1	7.7	6.7	5.8	7.0	6.7	7.0	5.7	8.0	5.5	4.0	6.8	6.2
OKC 19-9	4.6	5.6	5.2	5.0	6.9	7.4	5.4	5.5	8.0	8.0	4.5	6.8	6.0	7.2	5.1	7.8	5.2	3.6	6.9	6.0
* SHANGHAI	7.2	5.2	5.0	4.3	6.8	5.1	4.8	6.4	6.8	7.4	6.3	7.0	5.5	7.3	6.7	5.2	5.4	5.4	5.9	6.0
CARDINAL	6.3	6.3	4.9	5.6	6.3	7.7	6.2	6.1	5.3	5.5	6.0	5.5	6.7	6.5	5.6	5.7	5.0	4.6	5.8	5.9
PST-R69C	6.3	6.0	4.9	5.0	5.7	4.2	5.0	4.1	7.3	7.1	5.4	7.1	5.7	6.7	5.8	6.0	5.5	5.7	6.2	5.8
SWI-11	6.4	6.0	5.0	6.0	6.1	4.7	5.0	5.1	6.3	6.0	4.9	7.2	5.6	7.4	5.0	6.0	5.2	5.0	5.9	5.7
* MINI-VERDE	5.6	4.4	5.6	5.3	7.2	7.3	4.7	3.1	6.4	5.9	4.9	6.2	7.4	6.7	6.5	7.0	4.7	3.1	6.4	5.7
* SAVANNAH	5.4	5.9	5.2	5.4	6.2	3.8	4.8	5.7	5.9	7.0	5.1	6.7	4.7	6.4	5.7	5.9	5.2	4.9	5.8	5.6
SOUTHERN STAR (J-1224)	5.3	5.6	4.9	4.8	6.1	4.1	4.5	6.2	6.0	6.5	4.5	7.7	4.6	6.0	4.6	5.4	5.4	4.8	5.7	5.4
* SYDNEY (SWI-7)	5.6	5.2	4.9	4.8	5.4	3.8	4.0	5.9	5.6	7.0	4.3	7.2	4.0	5.7	5.3	5.1	5.5	5.2	5.3	5.3
* BLACKJACK	5.5	5.5	4.8	4.6	5.7	3.5	4.0	5.8	5.9	6.5	4.7	6.8	4.7	5.7	5.7	4.9	4.9	5.0	5.6	5.2
* MAJESTIC	4.6	5.1	5.1	4.6	6.3	4.0	3.9	5.6	5.7	5.8	5.3	7.3	4.1	5.7	6.0	5.0	4.8	5.1	5.7	5.2
J-540	4.6	5.7	4.8	5.0	5.7	4.1	3.6	5.8	5.3	6.4	4.2	6.9	4.2	5.7	5.5	5.1	5.3	5.2	5.7	5.2
* SUNDEVIL II	4.6	5.8	4.8	4.7	5.7	4.1	3.9	4.9	5.0	5.8	4.5	6.5	4.4	6.4	5.1	5.1	4.8	5.1	5.7	5.1
* SHANGRI LA	5.0	5.2	5.0	4.5	5.8	3.4	3.3	5.4	4.9	6.2	5.1	6.6	3.9	5.8	5.2	4.9	5.3	4.6	5.6	5.0
* PYRAMID	4.4	5.5	4.8	4.6	5.7	3.3	3.7	5.8	5.1	6.3	4.3	6.1	3.9	6.0	5.5	5.3	4.5	4.9	5.3	5.0
* MIRAGE	3.8	5.7	4.7	4.8	5.4	3.2	3.6	5.6	5.4	6.0	4.7	6.4	3.8	5.6	5.6	4.8	4.9	4.7	5.1	4.9
* BLUE-MUDA	4.2	5.2	4.8	4.3	5.7	3.1	3.5	5.7	4.9	5.9	4.7	6.6	4.3	5.5	5.4	5.0	5.0	5.0	5.1	4.9
* NUMEX-SAHARA	4.3	5.5	4.7	4.3	5.4	3.9	3.4	5.2	4.5	6.3	4.2	6.8	4.0	5.6	5.4	4.7	4.8	4.9	5.3	4.9
* JACKPOT	4.8	5.2	4.8	4.2	6.1	3.2	3.4	4.5	5.0	5.0	4.2	6.1	4.0	5.2	5.5	4.9	4.9	5.2	5.5	4.8
* ARIZONA COMMON	3.8	5.3	4.4	3.6	5.4	2.9	2.6	4.4	4.5	5.4	3.9	6.2	3.7	6.0	5.1	4.1	4.3	4.1	4.8	4.5
LSD VALUE	0.7	0.5	0.3	0.7	0.5	1.0	0.8	1.1	0.8	0.7	1.1	0.8	0.5	1.0	1.1	0.6	0.7	1.2	0.4	0.2
C.V. (%)	8.0	5.6	3.2	8.5	4.6	12.6	10.3	12.3	7.7	6.4	13.6	7.5	6.3	9.8	11.7	6.1	8.3	15.0	4.6	8.9

\* COMMERCIALY AVAILABLE IN THE USA IN 1999.

1/ TO DETERMINE STATISTICAL DIFFERENCES AMONG ENTRIES, SUBTRACT ONE ENTRY'S MEAN FROM ANOTHER ENTRY'S MEAN. STATISTICAL DIFFERENCES OCCUR WHEN THIS VALUE IS LARGER THAN THE CORRESPONDING LSD VALUE (LSD 0.05). 1/

2/ C.V. (COEFFICIENT OF VARIATION) INDICATES THE PERCENT VARIATION OF THE MEAN IN EACH COLUMN. 2/

Proceedings of the UCR Turfgrass and Landscape Management Research Conference and Field Day, September 1999

TABLE 1B.

MEAN TURFGRASS QUALITY RATINGS OF BERMUDAGRASS (SEEDED) CULTIVARS  
GROWN AT NINETEEN LOCATIONS IN THE U.S. 1/  
1998 DATA  
TURFGRASS QUALITY RATINGS 1-9; 9=IDEAL TURF 2/

NAME	AR1	AZ1	CA3	FL1	GA1	IL2	IN2	KS2	KY1	MO1	MO2	MO3	MS1	NM1	OK1	SC2	TX2	VA1	VA4	MEAN
OKS 95-1	6.8	6.3	5.3	5.3	6.3	7.1	6.1	6.7	7.9	8.1	6.7	7.7	5.5	7.5	6.9	7.0	5.7	5.4	6.5	6.6
PRINCESS	6.9	6.6	5.2	5.7	6.8	5.5	5.8	6.1	7.6	6.6	5.1	7.1	6.0	7.6	6.6	6.9	6.3	6.0	6.3	6.4
PST-R69C	6.3	6.0	4.9	5.0	5.7	4.2	5.0	4.1	7.3	7.1	5.4	7.1	5.7	6.7	5.8	6.0	5.5	5.7	6.2	5.8
SWI-11	6.4	6.0	5.0	6.0	6.1	4.7	5.0	5.1	6.3	6.0	4.9	7.2	5.6	7.4	5.0	6.0	5.2	5.0	5.9	5.7
SAVANNAH	5.4	5.9	5.2	5.4	6.2	3.8	4.8	5.7	5.9	7.0	5.1	6.7	4.7	6.4	5.7	5.9	5.2	4.9	5.8	5.6
SOUTHERN STAR (J-1224)	5.3	5.6	4.9	4.8	6.1	4.1	4.5	6.2	6.0	6.5	4.5	7.7	4.6	6.0	4.6	5.4	5.4	4.8	5.7	5.4
SYDNEY (SWI-7)	5.6	5.2	4.9	4.8	5.4	3.8	4.0	5.9	5.6	7.0	4.3	7.2	4.0	5.7	5.3	5.1	5.5	5.2	5.3	5.3
BLACKJACK	5.5	5.5	4.8	4.6	5.7	3.5	4.0	5.8	5.9	6.5	4.7	6.8	4.7	5.7	5.7	4.9	4.9	5.0	5.6	5.2
MAJESTIC	4.6	5.1	5.1	4.6	6.3	4.0	3.9	5.6	5.7	5.8	5.3	7.3	4.1	5.7	6.0	5.0	4.8	5.1	5.7	5.2
J-540	4.6	5.7	4.8	5.0	5.7	4.1	3.6	5.8	5.3	6.4	4.2	6.9	4.2	5.7	5.5	5.1	5.3	5.2	5.7	5.2
SUNDEVIL II	4.6	5.8	4.8	4.7	5.7	4.1	3.9	4.9	5.0	5.8	4.5	6.5	4.4	6.4	5.1	5.1	4.8	5.1	5.7	5.1
SHANGRI LA	5.0	5.2	5.0	4.5	5.8	3.4	3.3	5.4	4.9	6.2	5.1	6.6	3.9	5.8	5.2	4.9	5.3	4.6	5.6	5.0
PYRAMID	4.4	5.5	4.8	4.6	5.7	3.3	3.7	5.8	5.1	6.3	4.3	6.1	3.9	6.0	5.5	5.3	4.5	4.9	5.3	5.0
MIRAGE	3.8	5.7	4.7	4.8	5.4	3.2	3.6	5.6	5.4	6.0	4.7	6.4	3.8	5.6	5.6	4.8	4.9	4.7	5.1	4.9
BLUE-MUDA	4.2	5.2	4.8	4.3	5.7	3.1	3.5	5.7	4.9	5.9	4.7	6.6	4.3	5.5	5.4	5.0	5.0	5.0	5.1	4.9
NUMEX-SAHARA	4.3	5.5	4.7	4.3	5.4	3.9	3.4	5.2	4.5	6.3	4.2	6.8	4.0	5.6	5.4	4.7	4.8	4.9	5.3	4.9
JACKPOT	4.8	5.2	4.8	4.2	6.1	3.2	3.4	4.5	5.0	5.0	4.2	6.1	4.0	5.2	5.5	4.9	4.9	5.2	5.5	4.8
ARIZONA COMMON	3.8	5.3	4.4	3.6	5.4	2.9	2.6	4.4	4.5	5.4	3.9	6.2	3.7	6.0	5.1	4.1	4.3	4.1	4.8	4.5
LSD VALUE	0.7	0.5	0.3	0.6	0.5	1.0	0.8	1.3	0.9	0.8	1.1	0.8	0.6	1.1	1.2	0.6	0.7	1.2	0.5	0.2
C.V. (%)	9.0	5.5	3.5	7.7	5.6	15.4	12.0	15.0	9.7	7.9	14.7	7.6	8.7	10.8	13.6	7.1	8.9	15.2	5.3	10.0

TABLE 1C.

MEAN TURFGRASS QUALITY RATINGS OF BERMUDAGRASS (VEGETATIVE) CULTIVARS  
GROWN AT NINETEEN LOCATIONS IN THE U.S. 1/  
1998 DATA  
TURFGRASS QUALITY RATINGS 1-9; 9=IDEAL TURF 2/

NAME	AR1	AZ1	CA3	FL1	GA1	IL2	IN2	KS2	KY1	MO1	MO2	MO3	MS1	NM1	OK1	SC2	TX2	VA1	VA4	MEAN
OKC 18-4	7.2	6.0	5.2	5.6	7.4	6.7	6.7	6.6	6.4	7.8	6.5	7.3	6.3	7.5	6.7	7.5	5.8	5.6	6.1	6.6
TIFGREEN	6.9	5.5	5.9	5.5	6.9	7.0	6.2	5.7	7.2	8.0	5.9	7.0	6.9	7.2	6.5	7.3	6.2	5.1	6.6	6.5
TIFWAY	6.6	5.9	5.7	6.0	7.1	6.5	5.9	6.6	7.9	7.4	5.7	6.8	7.3	7.2	6.0	8.1	5.4	3.8	6.6	6.5
MIDLAWN	7.1	5.6	5.4	4.1	6.9	7.4	6.2	7.1	6.4	7.1	6.5	7.5	6.2	7.6	5.9	7.2	5.4	4.9	6.4	6.4
TIFSPORT (TIFT 94)	6.9	6.1	5.7	5.9	6.9	6.7	5.8	5.6	7.9	6.8	4.4	6.2	7.3	7.3	6.1	7.7	5.5	3.8	6.7	6.3
CN 2-9	6.4	5.8	5.4	5.2	6.8	6.1	5.7	6.1	7.7	6.7	5.8	7.0	6.7	7.0	5.7	8.0	5.5	4.0	6.8	6.2
OKC 19-9	4.6	5.6	5.2	5.0	6.9	7.4	5.4	5.5	8.0	8.0	4.5	6.8	6.0	7.2	5.1	7.8	5.2	3.6	6.9	6.0
SHANGHAI	7.2	5.2	5.0	4.3	6.8	5.1	4.8	6.4	6.8	7.4	6.3	7.0	5.5	7.3	6.7	5.2	5.4	5.4	5.9	6.0
CARDINAL	6.3	6.3	4.9	5.6	6.3	7.7	6.2	6.1	5.3	5.5	6.0	5.5	6.7	6.5	5.6	5.7	5.0	4.6	5.8	5.9
MINI-VERDE	5.6	4.4	5.6	5.3	7.2	7.3	4.7	3.1	6.4	5.9	4.9	6.2	7.4	6.7	6.5	7.0	4.7	3.1	6.4	5.7
LSD VALUE	0.7	0.5	0.2	0.8	0.3	1.0	0.8	0.6	0.4	0.4	1.1	0.8	0.3	0.9	0.8	0.6	0.6	1.0	0.3	0.2
C.V. (%)	6.6	5.7	2.8	9.7	3.1	9.6	8.1	5.9	3.9	3.4	11.7	7.3	2.7	8.2	8.3	4.8	7.3	14.4	3.3	6.9

1/ TO DETERMINE STATISTICAL DIFFERENCES AMONG ENTRIES, SUBTRACT ONE ENTRY'S MEAN FROM ANOTHER ENTRY'S MEAN.  
STATISTICAL DIFFERENCES OCCUR WHEN THIS VALUE IS LARGER THAN THE CORRESPONDING LSD VALUE (LSD 0.05).

2/ C.V. (COEFFICIENT OF VARIATION) INDICATES THE PERCENT VARIATION OF THE MEAN IN EACH COLUMN.

**1996 NTEP ZOYSIAGRASS TEST**  
 Est. 29 July 1996



9	12	14	15	11	10	13	16
1	6	5	8	3	18	19	17
XXX	7	2	13	14	18	12	16
3	8	15	10	17	11	19	9
XXX	1	6	2	7	5	YZ3	YZ7
8	3	XXX	5	1	2	6	7
18	14	16	10	17	9	12	19
					13	11	15

Seeded

1. ZEN 500
2. ZEN 400
3. ZENITH
5. J 37
6. CHINESE COMMON
7. Z 18
8. KOREAN COMMON

Vegetative

9. DALZ 9601
10. J 14
11. MIYAKO
12. HT 210
13. DE ANZA
14. VICTORIA
15. EL TORO
16. JAMUR
17. ZEON
18. MEYER
19. EMERALD

**Proceedings of the UCR Turfgrass and Landscape Management Research Conference and Field Day, September 1999**

TABLE 1A.

MEAN TURFGRASS QUALITY RATINGS OF ZOYSIAGRASS CULTIVARS  
GROWN AT SIXTEEN LOCATIONS IN THE U.S. 1/  
1998 DATA

TURFGRASS QUALITY RATINGS 1-9; 9=IDEAL TURF 2/

NAME	AR1	CA3	FL1	FL3	GA1	IL2	IN1	KS1	KY1	LA1	MO1	MS1	SC1	TX1	TX3	VA4	MEAN
* EMERALD	8.0	6.1	5.6	8.1	7.1	8.7	5.2	7.7	2.5	6.2	5.9	7.4	7.3	6.9	6.4	6.6	6.6
DALZ 9601	8.3	6.8	5.6	7.4	6.9	8.8	3.7	6.9	2.4	6.4	5.7	7.7	7.3	6.4	6.0	7.4	6.5
* EL TORO	6.4	5.6	6.8	8.0	6.3	4.3	5.4	6.3	7.3	6.4	6.1	5.8	7.1	6.5	6.6	6.6	6.4
* ZEON	7.9	6.5	5.7	7.7	7.1	8.9	3.1	6.3	1.8	6.4	4.6	7.6	6.8	6.5	6.2	7.2	6.3
* JAMUR	6.3	5.6	6.1	7.7	6.4	4.3	4.3	6.6	5.8	6.0	5.8	5.8	7.2	6.4	6.8	6.6	6.1
* VICTORIA	6.2	6.9	6.1	7.9	7.3	7.7	1.3	4.0	.	6.4	3.7	6.8	7.2	6.4	6.6	7.3	6.1
* DE ANZA	6.7	6.8	6.3	7.7	7.1	5.9	1.9	4.2	.	6.7	3.3	6.4	7.0	5.9	5.6	6.8	5.9
HT-210	5.8	5.3	5.3	7.3	6.1	8.5	1.0	4.0	.	6.2	1.7	7.2	7.6	6.8	6.8	6.5	5.7
J-14	5.4	4.3	4.3	6.8	5.8	5.7	6.0	5.2	7.1	5.8	5.4	5.2	7.1	5.8	5.8	5.7	5.7
* ZEN-400	5.1	4.9	5.1	6.8	6.1	3.1	5.7	6.1	7.5	5.8	5.6	5.3	7.0	5.5	5.1	5.7	5.6
* J-37	4.8	4.6	4.1	6.4	5.9	3.2	5.7	5.8	7.3	5.9	5.7	5.2	6.9	5.5	6.3	5.8	5.6
* MEYER	6.9	4.6	2.7	5.4	6.7	6.5	5.6	5.4	6.0	5.8	4.9	5.5	6.3	5.2	5.3	6.3	5.6
* ZENITH	4.6	4.8	3.3	5.9	6.6	4.7	4.6	5.3	8.2	5.9	4.3	5.0	6.8	5.5	5.8	5.6	5.4
* J-36	4.8	.	4.3	6.5	5.9	3.5	5.3	5.5	7.1	5.6	4.6	5.0	6.6	5.5	5.7	5.4	5.4
MIYAKO	5.2	5.1	5.9	7.5	5.9	2.3	2.4	5.3	4.7	6.4	5.6	5.3	6.6	5.7	6.8	6.1	5.4
* ZEN-500	4.6	5.0	3.3	6.5	6.2	3.4	5.6	4.3	7.2	5.6	3.8	5.3	7.3	5.0	6.0	5.9	5.3
* CHINESE COMMON	3.8	4.6	3.7	6.2	5.9	2.8	5.1	5.9	6.7	5.8	4.6	5.0	6.7	5.5	5.9	5.3	5.2
* KOREAN COMMON	3.9	4.0	3.8	4.8	5.8	2.4	2.9	4.4	4.1	5.3	2.1	5.0	6.3	4.8	5.7	5.4	4.4
* Z-18	1.2	4.0	3.4	3.8	6.1	.	1.2	4.4	2.4	5.7	1.6	5.4	4.2	.	3.5	5.4	3.7
LSD VALUE	1.4	0.6	1.0	0.7	0.5	0.7	1.1	0.8	1.7	0.4	1.2	0.5	0.5	0.7	1.3	0.4	0.2
C.V. (%)	15.6	6.7	12.6	6.6	5.1	8.3	16.9	9.7	16.3	4.1	16.5	5.2	4.9	7.1	13.2	4.3	9.7

\* COMMERCIALY AVAILABLE IN THE USA IN 1999.

1/ TO DETERMINE STATISTICAL DIFFERENCES AMONG ENTRIES, SUBTRACT ONE ENTRY'S MEAN FROM ANOTHER ENTRY'S MEAN.  
STATISTICAL DIFFERENCES OCCUR WHEN THIS VALUE IS LARGER THAN THE CORRESPONDING LSD VALUE (LSD 0.05).

2/ C.V. (COEFFICIENT OF VARIATION) INDICATES THE PERCENT VARIATION OF THE MEAN IN EACH COLUMN.

**Proceedings of the UCR Turfgrass and Landscape Management Research Conference and Field Day, September 1999**

TABLE 1B.

MEAN TURFGRASS QUALITY RATINGS OF ZOYSIAGRASS (SEDED) CULTIVARS  
GROWN AT SIXTEEN LOCATIONS IN THE U.S. 1/  
1998 DATA

NAME	TURFGRASS QUALITY RATINGS 1-9; 9=IDEAL TURF 2/																
	AR1	CA3	FL1	FL3	GA1	IL2	IN1	KS1	KY1	LA1	MO1	MS1	SC1	TX1	TX3	VA4	MEAN
ZEN-400	5.1	4.9	5.1	6.8	6.1	3.1	5.7	6.1	7.5	5.8	5.6	5.3	7.0	5.5	5.1	5.7	5.6
J-37	4.8	4.6	4.1	6.4	5.9	3.2	5.7	5.8	7.3	5.9	5.7	5.2	6.9	5.5	6.3	5.8	5.6
ZENITH	4.6	4.8	3.3	5.9	6.6	4.7	4.6	5.3	8.2	5.9	4.3	5.0	6.8	5.5	5.8	5.6	5.4
J-36	4.8	.	4.3	6.5	5.9	3.5	5.3	5.5	7.1	5.6	4.6	5.0	6.6	5.5	5.7	5.4	5.4
ZEN-500	4.6	5.0	3.3	6.5	6.2	3.4	5.6	4.3	7.2	5.6	3.8	5.3	7.3	5.0	6.0	5.9	5.3
CHINESE COMMON	3.8	4.6	3.7	6.2	5.9	2.8	5.1	5.9	6.7	5.8	4.6	5.0	6.7	5.5	5.9	5.3	5.2
KOREAN COMMON	3.9	4.0	3.8	4.8	5.8	2.4	2.9	4.4	4.1	5.3	2.1	5.0	6.3	4.8	5.7	5.4	4.4
Z-18	1.2	4.0	3.4	3.8	6.1	.	1.2	4.4	2.4	5.7	1.6	5.4	4.2	.	3.5	5.4	3.7
LSD VALUE	1.1	0.5	1.0	1.0	0.6	0.7	1.2	0.7	0.5	0.5	1.2	0.4	0.7	0.9	1.9	0.3	0.2
C.V. (%)	16.3	6.4	15.9	10.6	6.0	13.2	16.8	8.8	5.3	5.5	19.0	4.9	6.5	10.1	21.5	3.7	11.2

TABLE 1C.

MEAN TURFGRASS QUALITY RATINGS OF ZOYSIAGRASS (VEGETATIVE) CULTIVARS  
GROWN AT SIXTEEN LOCATIONS IN THE U.S. 1/  
1998 DATA

NAME	TURFGRASS QUALITY RATINGS 1-9; 9=IDEAL TURF 2/																
	AR1	CA3	FL1	FL3	GA1	IL2	IN1	KS1	KY1	LA1	MO1	MS1	SC1	TX1	TX3	VA4	MEAN
EMERALD	8.0	6.1	5.6	8.1	7.1	8.7	5.2	7.7	2.5	6.2	5.9	7.4	7.3	6.9	6.4	6.6	6.6
DALZ 9601	8.3	6.8	5.6	7.4	6.9	8.8	3.7	6.9	2.4	6.4	5.7	7.7	7.3	6.4	6.0	7.4	6.5
EL TORO	6.4	5.6	6.8	8.0	6.3	4.3	5.4	6.3	7.3	6.4	6.1	5.8	7.1	6.5	6.6	6.6	6.4
ZEON	7.9	6.5	5.7	7.7	7.1	8.9	3.1	6.3	1.8	6.4	4.6	7.6	6.8	6.5	6.2	7.2	6.3
JAMUR	6.3	5.6	6.1	7.7	6.4	4.3	4.3	6.6	5.8	6.0	5.8	5.8	7.2	6.4	6.8	6.6	6.1
VICTORIA	6.2	6.9	6.1	7.9	7.3	7.7	1.3	4.0	.	6.4	3.7	6.8	7.2	6.4	6.6	7.3	6.1
DE ANZA	6.7	6.8	6.3	7.7	7.1	5.9	1.9	4.2	.	6.7	3.3	6.4	7.0	5.9	5.6	6.8	5.9
HT-210	5.8	5.3	5.3	7.3	6.1	8.5	1.0	4.0	.	6.2	1.7	7.2	7.6	6.8	6.8	6.5	5.7
J-14	5.4	4.3	4.3	6.8	5.8	5.7	6.0	5.2	7.1	5.8	5.4	5.2	7.1	5.8	5.8	5.7	5.7
MEYER	6.9	4.6	2.7	5.4	6.7	6.5	5.6	5.4	6.0	5.8	4.9	5.5	6.3	5.2	5.3	6.3	5.6
MIYAKO	5.2	5.1	5.9	7.5	5.9	2.3	2.4	5.3	4.7	6.4	5.6	5.3	6.6	5.7	6.8	6.1	5.4
LSD VALUE	1.6	0.6	1.0	0.4	0.5	0.7	1.0	0.9	2.8	0.3	1.1	0.5	0.4	0.5	0.4	0.5	0.2
C.V. (%)	14.9	6.7	11.0	3.4	4.5	6.8	16.9	10.2	29.5	2.8	14.9	5.3	3.6	5.0	3.8	4.6	8.8

1/ TO DETERMINE STATISTICAL DIFFERENCES AMONG ENTRIES, SUBTRACT ONE ENTRY'S MEAN FROM ANOTHER ENTRY'S MEAN. STATISTICAL DIFFERENCES OCCUR WHEN THIS VALUE IS LARGER THAN THE CORRESPONDING LSD VALUE (LSD 0.05).

2/ C.V. (COEFFICIENT OF VARIATION) INDICATES THE PERCENT VARIATION OF THE MEAN IN EACH COLUMN.

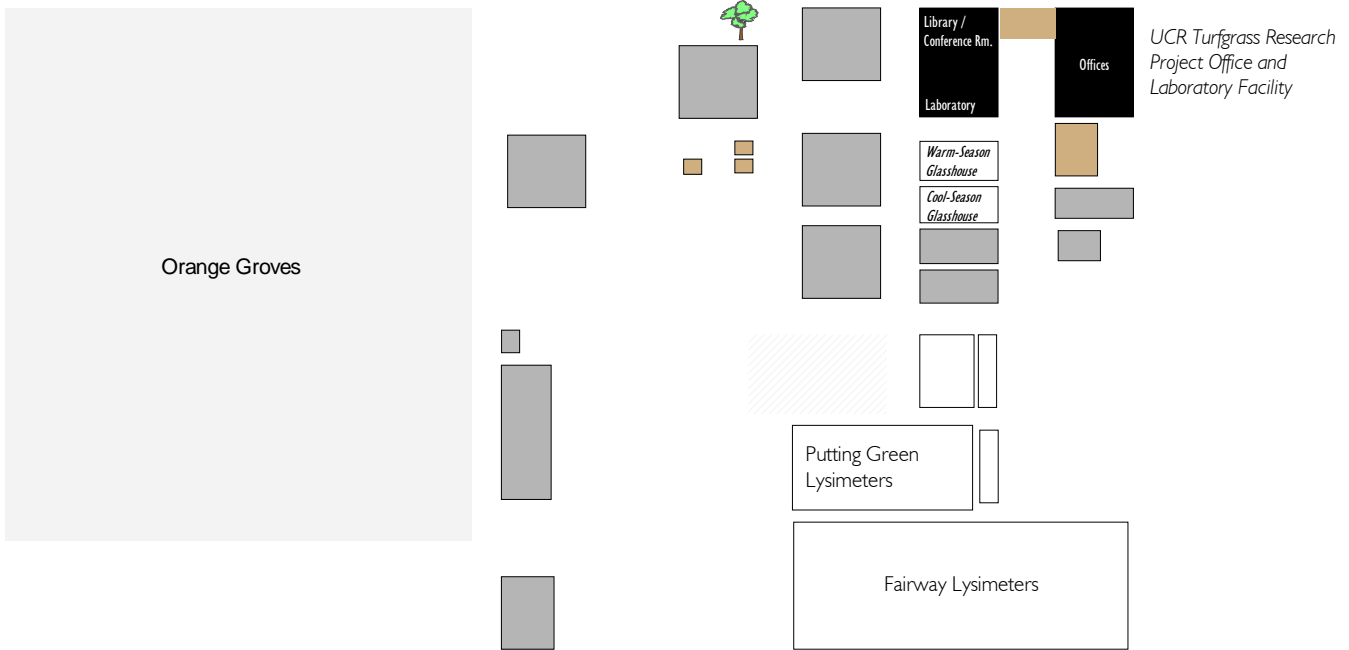
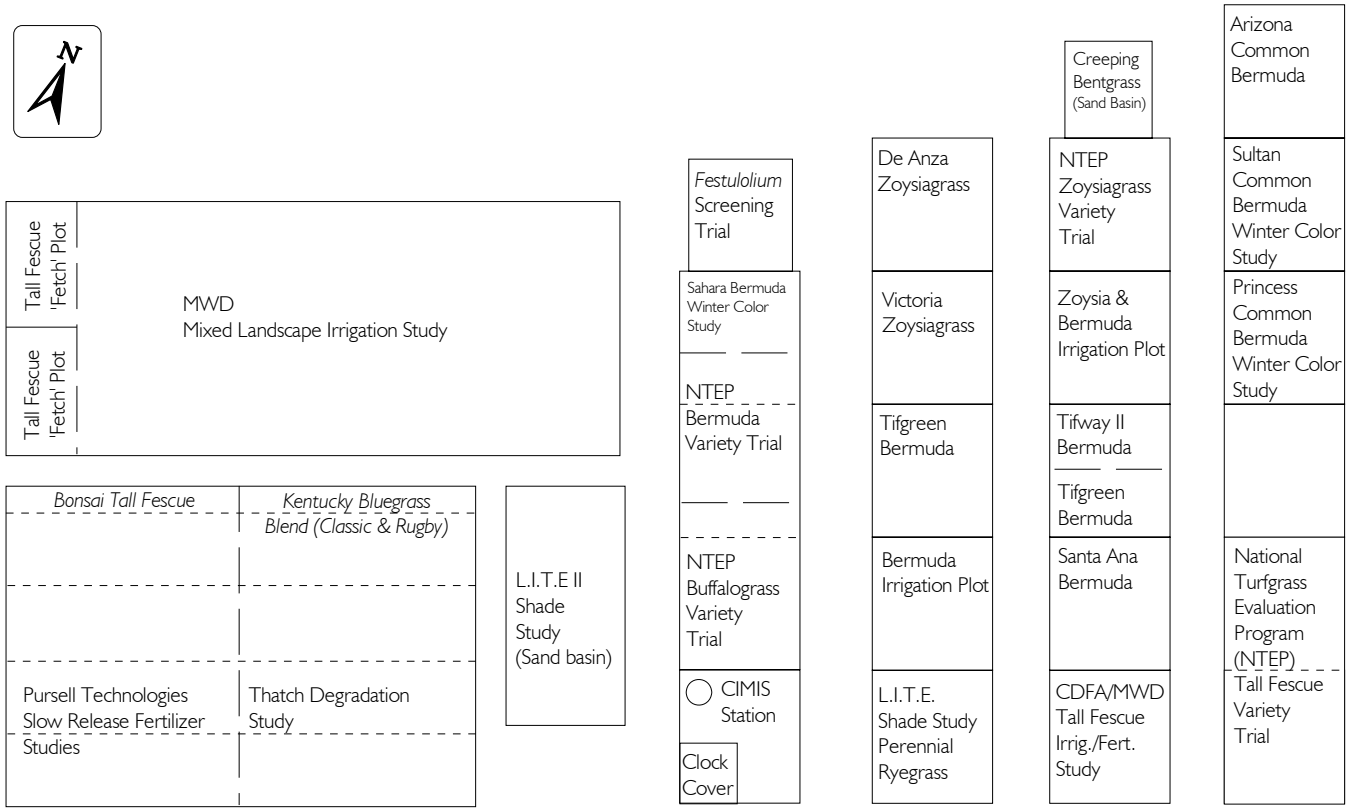

## UCR Turfgrass Field Station Map Field Day September 14, 1999



## **SPORTS FIELD MANAGEMENT**

**Stephen T. Cockerham and George H. Riechers**

*Agricultural Operations, University of California, Riverside, CA 92521-0124*

### **MOWING**

Low mowing produces denser turf and a faster playing surface but results in a shorter root system. Cool-season species maintained at a high mowing height then cut to a lower mowing height are more resistant to wear than grasses maintained at a low mowing height and allowed to grow taller. Scalping the sports field has a negative effects on appearance, resilience, and surface playability.

### **IRRIGATION**

Timing of irrigation in relation to use can be important to field playability. It is important to keep the turf actively growing, to insure high wear tolerance and recuperative ability, whenever the sports fields are in use. Timing and amount of irrigation should be based on plant requirements for. Water applied too close to field use can make fields soft and subject to excess damage, but irrigation prior to use on sand fields can improve footing.

### **DRAINAGE**

Playability is dramatically impacted if the sports field does not drain properly. Drainage can be provided in existing fields by making narrow slits and filling with sand or fine gravel.

### **FERTILIZATION**

Turfgrasses require nitrogen (N) in the largest amount of any of the fertilizer nutrients. Since turfgrass nutrition is one of the most critical elements in the quality of a sports field and one of the most frequently ignored, nitrogen is often severely deficient. Potassium (K) improves turfgrass wear tolerance, disease tolerance and aesthetic quality. Late season nitrogen applied before warm season grasses go dormant improves fall color retention. Nitrogen applied before the last mowing of cool season grasses improves spring greenup. The roots of warm-season grasses are still capable of absorbing some N while the plant is dormant.

### **AERATION**

Compaction on turf occurs primarily in the upper inch and shows up in reduced rooting depth when the soil is moist and a reduction in total root growth when the soil is dry. Spring sports traffic causes more soil compaction than fall or winter traffic. Compaction that results from sports traffic does not occur uniformly over the entire field. Soil sports fields should be core cultivated at least in early spring, summer, and fall. Severely compacted fields need frequent aeration. Dragging the field with a steel mat after aeration to breakup the cores and work soil back into the holes will help reduce thatch. Solid tines are used to shatter the soil below the surface and are most effective on dry soil. Spiking and slicing are effective to increase infiltration and reduce surface crusting. Spiking and slicing are quick temporary operations that can be performed just before a game due to limited surface disturbance.

### **TOPDRESSING**

Turf is topdressed to control thatch, provide a firm, uniform profile, and maintain a smooth playing surface. Topdressing an aerated surface and using a drag to work the material into the holes is a technique that can be used to gradually modify an existing soil medium. Topdressing is most useful on fields that are in reasonable playing condition where the surface drainage could be improved.



**ROLLING** A heavy, flat, steel roller is effective in smoothing the field and improving turf quality. Use of the roller can damage the turf by producing a similar affect as traffic on wear and compaction, therefore, core cultivation is an important associated program. Soil that is too dry is hard and does not respond to rolling. Soil that is too wet compacts too readily and is very difficult to manage.

**OVERSEEDING** Perennial ryegrass is the most durable species for overseeding bermudagrass. Spring transition is poor for the bermudagrass overseeded with the perennial ryegrass and subjected to traffic. Overseeding can be speeded by presoaking or pregerminating seed.

**SURFACTANTS** Surfactants reduce the surface tension of water which allows water movement through soil where it otherwise might be retained. Surfactants applied to wet spots in a sports field can help in temporarily increasing drainage, which reduces the effects of field softness and poor traction. Dry hard spots can sometimes be relieved with surfactants. The surfactant may allow water to penetrate the soil, softening the area.

## SPORTS TURF AND SHADE

Steven B. Ries and Stephen T. Cockerham

Agricultural Operations, University of California, Riverside, CA 92521-0124

Many natural grass sports fields are subject to limiting light which can range from tree and building shading to multi-use stadiums that are designed primarily for fan comfort at the expense of agronomic principles. Additionally, the most widely desired playing surface is natural grass. Suitable turfgrasses will be low light tolerant and provide a uniform surface for play. The objective of this study is to determine the efficacy of perennial ryegrass (*Lolium perenne*) as a sports surface under limiting light.

The study is conducted on LITE I, a plot that provides continuous shaded sunlight through the use of translucent shade cloth. The perennial ryegrass, a blend of 'Saturn', 'Elf', 'Evening Shade' and 'Allaire II' varieties (Stover Seeds Grand Slam Blend<sup>®</sup>), was seeded in early April 1999 at 8 lbs./1000 ft<sup>2</sup> and given about 18 weeks to establish. Shade was continually imposed starting in mid August. Mowing is done once or twice weekly at 1.5 inches with a rotary mower. Irrigation is applied at about 100% ET<sub>o</sub>. Simulated sports turf traffic is supplied by the Brinkman Traffic Simulator.

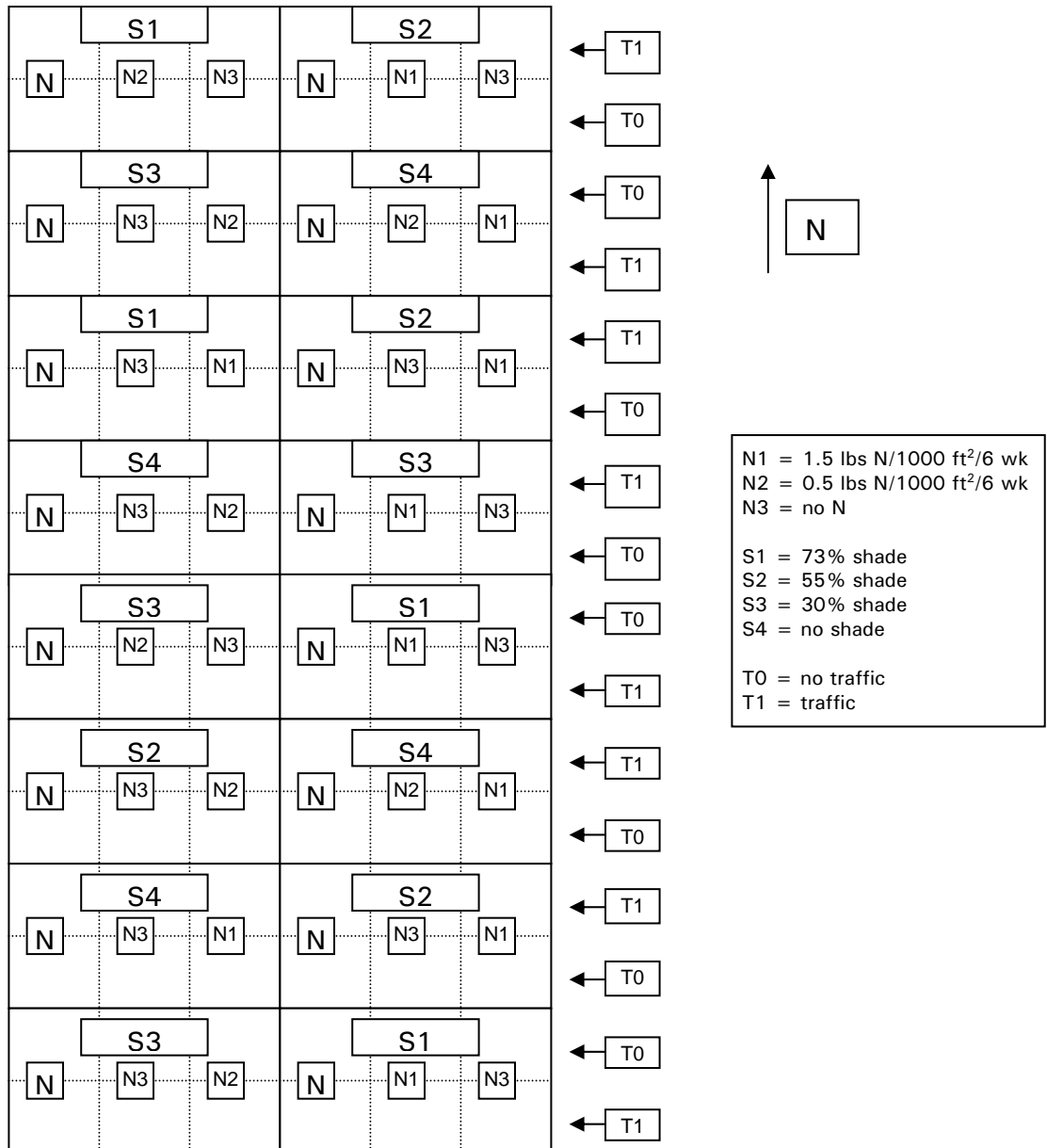

## **TALL FESCUE BEST MANAGEMENT PRACTICE FIELD STUDIES**

**Grant J. Klein<sup>1</sup>, William E. Richie<sup>1</sup>, Janet S. Hartin<sup>2</sup>, Victor A. Gibeault<sup>1</sup>, and Robert L. Green<sup>1</sup>**

<sup>1</sup>*Dept. of Botany and Plant Sciences, University of California, Riverside, CA 92521-0124*

<sup>2</sup>*University of California Cooperative Extension, San Bernardino and Los Angeles Counties  
777 E. Rialto Avenue, San Bernardino, CA 92514*

In 1998, two related three-year projects were initiated at UCR focusing on developing best management practices (BMPs) for landscape water conservation on tall fescue. One project, sponsored by the Metropolitan Water District of Southern California, is designed to test the effects of four irrigation treatments, including historical and real-time ET<sub>o</sub>-based treatments and two water-banking treatments. A second project, located at the same site, is sponsored by the California Department of Food and Agriculture's Fertilizer Research and Education Program (CDFA/FREP), and includes the four irrigation treatments as well as three N-fertility treatments. The CDFA/FREP study is designed to test the effects of the three N-fertility treatments in conjunction with the irrigation treatments, in order to develop BMPs for both N-fertility and irrigation on tall fescue.

The objectives of the projects, the plot plan, and a description of the data being collected follow (for details regarding the treatments themselves, see Table 1 (1998 protocol) and Table 2 (1999-2000 protocol) (pages 14-15). The current results for the second year of the projects will be discussed during the field presentation. Please note that these results have not yet been fully analyzed, as the second year of data collection is not yet complete, and thus no overall conclusions should be made about the success or failure of any particular treatment at this time.

### **Project Objectives:**

1. Both projects test irrigating tall fescue at a defined annual amount (80% historical ET<sub>o</sub> plus rain) with increased irrigation during the warm season to improve grass performance, and then proportionally adjusting the cool-season irrigation amount downward to make up for the addition of warm-season irrigation. These treatments are then compared to irrigating tall fescue at a constant rate of 1) 80% historical ET<sub>o</sub> plus rain and 2) 80% ET<sub>o</sub> (real time) plus rain.
2. The CDFA/FREP project also tests the influence of three annual N-fertility rates on the performance of tall fescue, in conjunction with the irrigation treatments (see Tables 1 and 2, on pages 14-15).
3. Both projects assess their respective treatment effects on tall fescue visual appearance and drought stress tolerance, growth (clipping yield), and soil water content. The CDFA/FREP project also assesses treatment effects on N uptake and soil N status.
4. Both projects develop BMPs for tall fescue relating to turfgrass water conservation. The CDFA/FREP project also develops BMPs for N-fertilizer use efficiency, in terms of visual quality and drought stress tolerance, growth (clipping yields), and N uptake.
5. The CDFA/FREP project also includes outreach activities, including the publication of trade journal articles and giving oral presentations both of which are to emphasize the importance and methods of turfgrass BMPs for irrigation and fertilization.

---

This research is funded in part by the 1) State of California, Department of Food and Agriculture, Fertilizer Research and Education Program, and 2) Metropolitan Water District of Southern California. Thanks are given to the Soil Plant Laboratory, Inc., Orange, CA, for providing N tissue analysis.



**Table 1. Protocol for measurements collected during the MWD and CDFA/FREP tall fescue best management practices studies.**

Measurement	Frequency	Method and other comments
1. Visual turfgrass quality	Every 2 weeks (after weekly mowing)	1 to 9 scale; 1 = worst quality and 9 = best quality for tall fescue
2. Visual turfgrass color	Same time as quality	1 to 9 scale; 1 = worst (brown) and 9 = best (dark green) color for tall fescue
3. Visual estimate of percent leaves wilted and rolled	Monthly (MWD), or as needed (CDFA/FREP)	1 to 100 percent of entire canopy of each plot or subplot, respectively.
4. Visual estimate of percent leaves fired and brown to yellow	Same time as percent leaves wilted and rolled	1 to 100 percent of entire canopy of each plot or subplot.
5. Clipping yield, TKN, and N uptake	CDFA/FREP: Samples taken over four growth periods (starting one month following N-fertility treatments), each spanning four consecutive weekly clipping yields. Generally, periods are April 1 to 30, June 15 to July 15, Sept. 15 to Oct. 15, and Nov. 15 to Dec. 15. MWD: Clipping yield only. Taken Feb., April, June, Sept., and Nov. Clipping yield water content measured concurrently.	Yields represent 7-days' growth and are collected with the same mower used for routine mowing, except for a specially constructed collection box. Subsamples are from 17.5% (MWD) or 43.3% (CDFA/FREP) of the total surface area of each plot or subplot, respectively. Samples are dried and weighed via standard procedures. CDFA/FREP: The four weekly yields within each growth period are pooled by the 36 subplots and prepared for TKN analysis via standard procedures at the DANR laboratory at UC Davis. Tissue N analysis also via the nitrogen gas analyzer method. With appropriate calculations, N uptake during the four, four-week growth periods is determined. MWD: Clipping yield water content (fresh weight-dry weight/dry weight) calculations are made at the time of collection and after drying via standard procedures.
6. Relative leaf water content (MWD)	At least once per quarter (Feb., April, June, Sept., Nov.); four days after mowing and one day prior to irrigation, when plots are the driest.	Two subsamples of 8 to 10 fully expanded, nonsenescent leaf blades are harvested from each plot (after dew has evaporated) and fresh weight determined. Rehydrated weight taken after samples placed in distilled water for 12 to 16 hr. Dry weight taken after samples are dried via standard procedures. RLWC determined by appropriate calculations.
6. Volumetric soil-water content; soil-water tension	Once every month (volumetric soil-water content) and once every week (soil-water tension) on Tuesdays. Note that soil-water measurements will be collected from MWD plots (the Jaguar III tall fescue) (Fig. 1).	Volumetric soil-water content at 9-, 12-, 18-, 24-, 36-, and 48-inch depths via the neutron-scattering method (Campbell Pacific Nuclear, Model 503 Hydroprobe). Two neutron probe access tubes/irrigation cell, at the same center locations of each Jaguar III plot (Fig. 1). Soil-water tension at the 6- and 12-inch depths using Watermark granular matrix sensors connected to a Watermark soil-moisture meter. The two sensors are at the same location as the neutron probe access tubes.
7. Soil NO <sub>3</sub> -N, NH <sub>4</sub> -N, TKN (CDFA/FREP)	October 1	Soil samples collected from each CDFA/FREP subplot and prepared according to standard procedures. Analysis conducted at the DANR laboratory at UC Davis.
8. Weather data	Continuous	Obtained from a CIMIS station 169 ft from the center of the research plot. Soil temperature data obtained from a data logger installed at the research plot.

All MWD and soil-moisture data are analyzed for the irrigation treatments as a RCB design. All CDFA/FREP data (except soil moisture data) are statistically analyzed according to a split-plot design, with main-plots (irrigation treatments) arranged in RCB design. A repeated-measures design also is used within and between years when appropriate. Weather data is summarized by week and is not statistically analyzed.

**Table 2. Protocol for research plot management and associated information for the MWD and CDFA/FREP tall fescue best management practices studies.**

Activity	Comment
1. Mowing	Each Friday, using a walk-behind, rotary mower set at a 1.5-inch mowing height. Clippings collected. Note that the Jaguar III tall fescue is mowed the same as the Shortstop tall fescue.
2. Irrigation	Two irrigation events/week, according to irrigation treatment protocol, on Wednesday and Saturday morning, before sunrise. Irrigation water quality is excellent because it is the Riverside potable water supply.
3. Irrigation-system check	The vertical of all heads, checked with a level and adjusted once every 2 weeks. Clock operation, irrigation run times via hour meters hooked parallel with solenoid valves, and pressure of the irrigation system routinely monitored to ensure accurate irrigation treatments. Catch-can tests conducted on each irrigation cell in January and June. Most recent application rates of each irrigation cell are then used in calculating irrigation run times.
4. Fertility	P <sub>2</sub> O <sub>5</sub> and K <sub>2</sub> O applied as needed based on annual soil tests beginning December 1997. The native soil of the research plot normally possesses sufficient levels of these elements. Native soil = Hanford fine sand loam; pH = 7.0 to 7.3; P-bicarbonate <sup>z</sup> > 20 ppm; exchangeable K <sup>y</sup> > 80 ppm; CEC = 13 meq/100 g; SAR=2; ESP (%) = 2.0; soluble Ca <sup>x</sup> > 6.0 meq/L; soluble Na <sup>w</sup> > 5.0 meq/L; 12% clay; 51% sand; and 37% silt.
5. Pesticide application	To ensure representative tall fescue, pesticides will be applied as needed.

<sup>z</sup> Extractable phosphate based on alkaline extraction by 0.5 Normal NaHCO<sub>3</sub>. Plant available phosphate for soils with pH greater than 6.5 by ascorbic acid reduction of phosphomolybdate complex and measurement by spectrophotometry. (As cited in *DANR Analytical Lab Soil Citations*.)

<sup>y</sup> Equilibrium extraction of soil for plant available exchangeable potassium performed using 1.0 Normal ammonium acetate (pH 7.0) with subsequent determination by atomic absorption/emission spectrometry. (As cited in *DANR Analytical Lab Soil Citations*.)

<sup>x</sup> Amounts of soluble calcium in the saturated paste extracted by inductively coupled plasma atomic emission spectrometry. (As cited in *DANR Analytical Lab Soil Citations*.)

<sup>w</sup> Amount of soluble sodium in the saturated paste extracted by emission spectrometry. (As cited in *DANR Analytical Lab Soil Citations*.)

## **IRRIGATION PRACTICES AND WATER CONSERVATION OPPORTUNITIES**

**William E. Richie and Robert L. Green**

*Dept. of Botany and Plant Sciences, University of California, Riverside, CA 92521-0124*

Fresh water is a precious resource in southern California where average annual rainfall is 10 inches. (See Table 2, page 15). A warm-season turfgrass in this region, such as bermudagrass or zoysiagrass, will theoretically require 45 inches of irrigation water ( $ET_{crop}/DU$ ) (please see below) per year to maintain acceptable appearance and function. The availability of irrigation water to meet these requirements has, in recent years, been constrained by both the increase in water demands due to growing urbanization and multiple years of drought conditions. This has generated a need for water conservation efforts, including determining recommendations for landscape water allocation. While there is justification for this, there is also a need to be more efficient with irrigation practices, either through scheduling irrigation according to plant needs, or by ensuring that irrigation water is more readily available for plant use.

Irrigation efficiency can be improved by scheduling irrigation according to reference evapotranspiration ( $ET_o$ ).  $ET_o$  is an estimate of the amount of water used by a healthy, 4- to 6-inch tall stand of cool-season turfgrass, such as tall fescue. It can be calculated in real-time from specific weather parameters, and it also is available in tabular form as historical average values. Actual turfgrass water use ( $ET_{crop}$ ) is calculated as a percentage of  $ET_o$  by multiplying the latter by crop coefficients ( $K_c$ ) which are specific for the crop of interest. For example, cool-season turfgrasses have an annual average  $K_c$  of 0.8 and warm-season turfgrasses have an annual average  $K_c$  of 0.6. Annual average water use for a cool-season turfgrass is therefore 80% of  $ET_o$  ( $ET_o \times 0.8$ ), or approximately 45 inches in Riverside, CA. Annual average  $ET_{crop}$  for a warm-season turfgrass in Riverside is 34 inches.  $ET_{crop}$  should then be divided by the distribution uniformity (DU) of the irrigation system. This increases the required water application because DU values are less than unity. In the previous example, if DU was 0.75 (a fair value for typical irrigation systems) then actual annual irrigation requirement for a cool-season turfgrass = 45 inches ( $80\% ET_o$ )/0.75 = 60 inches (107%  $ET_o$ ). For a warm-season turfgrass  $ET_{crop}/DU = 34$  inches ( $60\% ET_o$ )/0.75 = 45 inches (80%  $ET_o$ ).

Irrigation efficiency is maximized by ensuring that irrigation system distribution uniformity is as high as possible. Systems running within the manufacturer's recommended operating pressure range will have higher DU. Rotor or impact-type heads typically provide superior uniformity to spray heads, as long as nozzle sizes are selected for balanced precipitation. Sprinklers should be spaced for head-to-head coverage, and should be aligned as vertically as possible. Finally, irrigation should occur when wind does not interfere with spray patterns. This practice also reduces water loss from evaporation.

Soil water sensors also can be an effective tool for increasing irrigation efficiency. These devices work by preventing irrigation valves from opening when soil water content is above a certain level, either from irrigation or rainfall. Sensors are installed in the root zone, and are wired either into the irrigation controller, or in series with each irrigation valve.

Irrigation efficiency can be further increased by ensuring that all applied water reaches the root zone where it is available for uptake and plant processes. Certain management practices can aid water infiltration into the soil. Reducing water loss via evaporation has been previously mentioned. Core cultivation can reduce hydrophobic thatch layers and soil compaction, thus improving water infiltration. Irrigation can be applied with shorter and/or repeated cycles with

sufficient time between cycles to allow water to infiltrate into the soil. Irrigation systems with lower precipitation rates (such as those with rotor or impact heads, or drip systems) also can be employed to minimize runoff and water waste. Another strategy is to employ soil penetrants or wetting agents (surfactants) which help reduce hydrophobic conditions and improve water infiltration.



## **FALL BERMUDAGRASS MANAGEMENT FOR COLOR RETENTION**

**Victor A. Gibeault and Richard Autio**

*Dept. of Botany and Plant Sciences, University of California, Riverside, CA 92521-0124*

### **INTRODUCTION**

The warm-season grasses, common and hybrid bermudagrasses, are used widely in Southern California for many turfgrass purposes, including for aesthetics, for function and for recreation. They are well adapted to the region and are resource efficient when water and nutrient requirements are considered. They are tough grasses that recover from traffic injury quickly during the seasons of their growth, which is late spring, summer, and early fall. Growth slows and ultimately stops in late fall and winter and plant dormancy results; if used intensely during the winter season, bermudagrass fields are worn and can be severely damaged.

Chilling temperatures that characterize Southern California during the late fall and winter interact with high light intensity and result in a loss of chlorophyll causing the dormancy. The appearance of anthocyanin may be observed as chlorophyll degradation exceeds synthesis; ultimately, the warm-season turfgrasses lose all green color until temperatures increase in late winter or early spring. Normally, the winter temperatures in Southern California are very close to threshold temperatures that cause chlorophyll degradation so plant selection and culture can influence the presence and degree of dormancy. In that regard, it is the objective of this project to examine cultural programs that influence dormancy or turfgrass color loss of three bermudagrasses during the late fall and winter in Riverside California.

### **CONCLUSIONS**

In this first year of a two year study, nitrogen was the most important variable examined regarding opportunities for extending color of bermudagrass cultivars into the late fall and early winter in Southern California. Iron fertilization and vertical mowing either showed no effect on winter color retention or very minimal influence, with the October vertical mowing being too late in the season for regrowth to occur, especially with Princess and Sultan.

Iron staining of Princess and Sultan was unacceptable in late season application, again apparently due to the lack of late season growth.

General observations indicated that Princess appeared to require a hybrid bermudagrass maintenance level. Higher nitrogen was noted to reduce scalping of the bermudagrasses as did the August vertical mowing.

The loss of color in all cultivars was associated with the dramatic drop in soil temperatures starting in early December of the test year. (At that time four inch soil temperatures dropped into the low 50's (F). The raise in soil temperatures in late January and February were reflected in color response in Sahara bermudagrass but not Princess and Sultan.

This study will continue through 1999 and into early 2000.



North

BERMUDA FALL COLOR  
Sultan, Princess and Sahara  
Established August 21, 1998

2 C	3	1	5	4	6	8	7	9
B								
A								
1 B	7	8	2	3	9	6	4	5
A								
C								
9 C	6	4	8	5	7	2	1	3
A								
B								

Main Treatments

1. calcium nitrate, 1#N/M/mo. (Sultan & Princess: 263.6g; Sahara: 175.7g)
2. calcium nitrate, 1#N/M/2mo.
3. iron, 2oz.Fe/M/mo. (Sultan & Princess: 16.5g; Sahara: 11g)
4. iron, 4oz.Fe/M/mo. (Sultan & Princess: 33g; Sahara: 22g)
5. trt. 1 + trt. 3
6. trt. 1 + trt. 4
7. trt. 2 + 2oz.Fe/M/2mo.
8. trt. 2 + 4oz.Fe/M/2mo.
9. control

Split Block

- A. Vertical mow August 19                      Ryan renovator = 2' wide, single pass, 1.75" deep.
- B. Vertical mow October 5
- C. No vertical mow

Plot size: Princess & Sultan = 45'e-w x 54'n-s (fertility = 5'x18', sub-plots = 5'x6')  
Sahara = 45'e-w x 36'n-s (fertility = 5'x12', sub-plots = 5'x4')  
2' aisle between replications, 3 reps.

## **NATIONAL TALL FESCUE CULTIVAR TRIAL RESULTS: 1999**

**J. Michael Henry**

**University of California Cooperative Extension, Riverside County**

*21150 Box Springs Road, Moreno Valley, CA 92557-8708*

The National Turfgrass Evaluation Program (NTEP) results for the 1996 Tall Fescue study are presented in Table 1. The study was established at the UC Riverside Turfgrass Research Lab in October of 1997. The listing of turfgrass quality scores for this study are under the heading CA3 (CA1 is for the results from the UC Research and Extension Center in Santa Clara, CA). The United States Department of Agriculture, selected Land Grant Universities, and supporting seed companies started the National Turfgrass Evaluation Program in the early 1970's. The goal was to provide an unbiased, national system of evaluating new turfgrass cultivars, mainly through Land-grant Universities with turfgrass research programs. In some cases evaluations are conducted by seed companies or sod growers.

The tall fescue evaluations have been underway since the early 1980's. The ranking by national means (average turf quality scores) are presented in the far right column of Table 1. The highest ranked cultivar is at the top of the table and the lowest is at the bottom. It is important to note that the California rankings are different from the national ranking. Those wishing to use these tables should look at the local evaluation for a good estimate of the cultivar performance in southern California (CA3) or northern California (CA1). For instance, 'Millenium' was ranked the highest in our tests at UCR, while 'Rembrandt' had a slightly lower turf quality mean score here (but not significantly lower). Nationally, 'Rembrandt' was the highest ranked cultivar and 'Millenium' was ranked just below (significantly). These numbers represent the overall turfgrass quality on a yearly average and some variation between summer and winter performance may be underrepresented by the yearly average scores.

To determine if the scores between two or more cultivars are significantly different (is one really better than the other?) subtract the scores and see if the difference between them is more than 0.2 (national means) or 0.5 (UC Riverside means). Those with greater differences than the LSD values listed below the table for the appropriate column are scientifically (significantly) different.

The results of this evaluation of new tall fescue cultivars and their comparison to older "pasture" type tall fescues used for turf situations prior to 1980 is quite similar to past evaluations. The majority of cultivars are closely packed together around the 5.5 - 6.0 turf quality score level. There is a great improvement over the older tall fescue pasture types ('Kentucky 31') but generally not a great difference between most of the new cultivars.



**1996 NTEP TALL FESCUE TRIAL**

est. --Oct. 1997

plot size = 3.5'E-Wx7'N-S

56	76	93	98	99	5	36	71	31	52	16	64	33	1	73	87
80	79	22	38	21	102	55	48	86	45	103	51	59	78	49	112
82	100	96	125	14	97	20	23	111	32	90	92	128	114	122	12
118	4	58	117	109	75	41	28	13	127	123	66	15	50	65	101
29	106	34	24	107	69	95	110	108	120	35	62	94	81	84	37
77	129	115	2	11	10	57	74	42	72	91	39	61	104	44	47
68	46	116	25	54	9	7	119	8	70	3	85	53	40	6	124
27	18	88	19	121	43	126	30	26	63	113	83	17	105	60	89
67	1	2	3	4	5	6	7	8	9	10	11	12	13	14	15
16	17	18	19	20	21	22	23	24	25	26	27	28	29	30	31
32	33	34	35	36	37	38	39	40	41	42	43	44	45	46	47
48	49	50	51	52	53	54	55	56	57	58	59	60	61	62	63
64	65	66	67	68	69	70	71	72	73	74	75	76	77	78	79
80	81	82	83	84	85	86	87	88	89	90	91	92	93	94	95
96	97	98	99	100	101	102	103	104	105	106	107	108	109	110	111
112	113	114	115	116	117	118	119	120	121	122	123	124	125	126	127
128	129	29	118	60	61	20	8	82	59	6	5	125	115	89	67
70	49	106	80	84	102	72	117	43	40	123	47	122	121	25	56
76	124	78	65	2	103	90	36	21	32	68	104	126	28	99	33
114	54	66	42	14	13	15	129	4	83	111	100	57	81	97	44
27	64	19	7	69	55	116	58	17	92	31	96	48	22	46	23
39	105	120	62	51	79	127	24	75	95	34	74	12	107	11	37
91	77	86	3	41	128	52	18	108	113	63	30	1	88	53	73
101	71	9	45	85	26	10	98	112	16	110	87	109	93	119	50
94	35	38	X	X	X	X	X	X	X	X	X	X	X	X	X

Proceedings of the UCR Turfgrass and Landscape Management Research Conference and Field Day, September 1999

TABLE 1.

MEAN TURFGRASS QUALITY RATINGS OF TALL FESCUE CULTIVARS  
GROWN IN FULL SUN AT TWENTY-SEVEN LOCATIONS IN THE U.S. 1/  
1998 DATA

TURFGRASS QUALITY RATINGS 1-9; 9=IDEAL TURF 2/

NAME	AR1	CA1	CA3	DE1	GA1	IA1	IL1	IL2	IN1	KS2	KY1	MD1	ME1	MI1	MO1	MO3	NE1	NJ1	NJ2	NY1	OH1	OK1	SC2	UT1	VA1	VA4	WA1	MEAN
* REMBRANDT (LTP-4026 E+)	6.5	6.8	6.0	6.1	6.4	5.3	5.9	8.0	6.5	7.0	8.3	5.8	6.2	6.3	6.3	7.1	6.6	6.0	6.2	3.7	8.2	6.9	6.0	5.9	6.1	6.1	5.9	6.4
* PLANTATION (PENNINGTON-1901)	6.2	7.0	6.1	5.2	6.6	6.0	5.4	7.2	6.4	6.9	8.3	5.4	6.5	6.5	6.4	7.3	6.6	6.0	5.8	4.4	8.3	6.9	5.7	6.1	6.1	5.8	6.0	6.3
* MILLENNIUM (TMI-RER)	6.0	6.9	6.2	5.9	6.3	5.8	5.7	7.3	6.4	6.6	8.3	5.1	6.9	6.3	5.8	6.6	6.2	5.9	6.0	4.8	8.0	6.7	5.4	4.8	5.8	6.1	5.9	6.2
* SHENANDOAH II (WRS2)	6.4	6.9	6.0	6.7	6.0	5.6	5.7	7.8	6.2	6.6	7.7	5.3	5.6	6.0	6.0	6.9	6.2	5.6	5.5	4.3	8.1	6.6	5.4	5.3	6.3	6.0	6.1	6.2
PICK RT-95	6.0	6.8	5.9	6.2	6.3	4.7	5.8	7.6	6.5	6.4	7.7	4.6	6.2	6.1	5.8	7.3	6.4	5.7	6.1	3.6	8.1	6.3	5.2	5.7	5.6	6.4	5.8	6.1
* SCORPION (ZPS-2PTF)	6.1	6.7	6.0	4.8	6.1	5.3	6.0	7.8	6.4	6.8	7.6	5.2	5.7	6.0	6.4	6.9	6.3	5.5	5.5	3.8	8.3	6.3	5.2	5.6	5.4	6.1	6.0	6.1
* MASTERPIECE (LTP-SD-TF)	6.1	6.8	5.7	5.5	7.0	5.1	5.7	7.3	6.7	6.9	8.0	5.0	5.7	5.9	5.6	7.0	6.3	5.7	5.5	3.8	7.7	6.4	5.4	5.0	5.6	6.4	6.0	6.1
* JAGUAR 3	6.9	7.0	6.0	5.1	6.4	5.0	5.7	7.7	6.3	6.7	7.7	4.4	5.8	5.9	5.8	6.9	5.7	5.2	5.3	4.2	8.3	6.6	5.2	5.0	5.9	6.0	5.7	6.0
* CROSSFIRE II	5.7	6.8	5.8	5.8	6.3	5.7	5.8	7.6	6.4	6.8	7.3	4.0	6.1	5.8	5.9	6.6	6.8	5.8	5.5	4.5	7.8	6.6	5.2	4.8	5.7	6.0	5.7	6.0
* WATCHDOG (PICK FA B-93)	6.1	6.7	6.0	5.4	5.5	5.5	5.3	7.0	6.5	6.4	7.8	5.1	7.1	6.3	5.5	6.5	5.9	5.3	5.7	3.2	8.1	6.7	5.4	5.9	5.3	6.2	5.6	6.0
* OLYMPIC GOLD (PST-5E5)	6.1	6.9	6.0	6.1	6.5	5.1	5.5	6.4	6.1	6.5	8.1	4.8	6.3	6.5	5.6	6.7	6.2	4.9	4.7	4.3	7.9	6.5	5.2	4.7	6.1	6.1	5.8	6.0
* COYOTE	6.2	6.6	5.6	5.3	5.7	5.3	5.4	6.8	6.4	6.4	7.4	4.9	7.3	5.8	5.9	6.6	6.4	5.4	5.4	3.2	8.3	6.6	5.3	5.0	5.9	6.0	5.7	6.0
PST-523	6.0	6.8	5.8	5.6	6.1	5.4	5.8	7.3	6.3	6.8	7.6	4.9	5.7	6.0	6.0	6.3	6.3	4.8	5.0	3.6	7.8	6.7	5.3	5.3	5.5	6.1	5.8	5.9
* REBEL SENTRY (AA-A91)	5.8	6.7	5.8	5.4	5.9	5.5	5.6	6.7	6.2	6.8	7.7	5.8	5.7	5.6	5.9	7.0	6.8	4.6	5.0	3.3	8.2	6.4	5.6	5.2	5.4	5.9	5.8	5.9
PST-5M5	6.1	6.4	6.1	5.3	5.8	5.3	5.4	7.2	6.3	6.9	7.8	5.0	6.4	6.3	6.0	6.8	6.4	4.5	4.6	2.4	7.5	6.7	5.1	5.6	6.2	6.2	5.7	5.9
* ARID 3 (J-98)	6.0	6.8	5.7	5.9	5.5	4.7	5.1	6.3	6.4	6.7	8.3	5.5	6.2	5.7	5.5	7.2	6.5	5.3	4.8	4.5	8.1	6.0	5.6	5.4	5.9	5.9	5.9	5.9
CU9502T	5.4	6.9	5.3	6.2	5.8	5.0	5.3	6.0	6.3	6.7	8.0	5.4	6.2	6.3	5.5	6.4	6.7	4.6	4.6	4.2	8.0	6.2	5.4	5.3	6.0	6.1	5.7	5.9
MB 29	6.6	6.7	5.7	5.7	5.7	5.2	5.1	5.7	6.2	6.5	8.2	4.7	6.3	6.3	6.0	6.7	5.4	4.7	4.7	3.8	7.8	6.3	5.8	5.0	5.8	6.0	6.1	5.9
MB 26	6.0	7.0	6.0	5.9	4.3	4.8	5.0	6.1	6.2	6.8	7.5	4.7	6.3	6.1	5.9	7.2	6.4	4.9	5.1	4.4	8.7	6.4	5.6	4.7	5.1	5.6	6.0	5.9
MB 211	6.3	6.8	5.7	5.9	5.6	4.3	5.1	6.7	6.0	6.9	7.8	4.4	6.4	6.4	6.0	6.6	6.4	4.7	4.6	3.5	8.1	6.5	5.7	5.3	5.6	5.7	5.7	5.9
* WOLFPACK (PST-R5TK)	5.4	6.4	6.0	5.1	6.7	5.3	5.8	6.8	6.1	6.6	7.6	5.3	5.1	6.3	5.5	6.6	6.1	5.0	5.5	2.8	7.4	6.9	5.2	5.0	6.2	6.0	5.7	5.9
* TAR HEEL	5.9	6.9	5.9	4.9	6.0	5.2	5.7	7.0	5.9	6.7	7.6	4.3	5.7	6.3	5.7	6.4	5.4	5.3	5.3	3.4	7.7	6.3	5.4	5.8	6.0	5.9	5.7	5.9
* SOUTHERN CHOICE	5.9	6.7	6.0	5.8	5.8	5.2	5.0	6.7	6.0	6.9	7.3	5.0	6.3	6.4	5.4	6.3	6.8	4.3	4.8	4.2	7.8	6.3	5.1	4.9	5.7	5.9	5.6	5.9
MB 212	6.1	6.9	5.5	5.3	5.8	5.1	4.9	7.2	6.0	6.8	8.0	4.0	6.5	6.5	5.6	6.7	6.2	5.0	4.9	2.7	7.8	6.4	5.7	5.1	5.6	6.1	5.8	5.9
MB 213	6.6	6.7	5.6	6.1	5.2	5.2	4.7	5.9	6.0	6.9	7.5	4.2	6.5	6.0	5.9	7.1	6.4	5.4	4.5	4.1	7.8	6.1	5.6	4.9	5.5	5.5	6.1	5.9
* MUSTANG II	6.2	6.6	5.6	6.1	6.3	5.1	5.7	7.4	6.1	6.9	7.4	4.3	6.2	6.1	5.4	6.2	5.9	4.3	5.0	4.1	7.5	6.7	5.9	4.9	4.9	6.0	5.4	5.9
* GAZELLE	5.2	7.0	5.7	5.0	5.2	5.2	5.4	6.8	6.7	6.5	7.6	5.2	5.8	5.6	5.1	6.5	6.3	5.3	5.9	2.9	8.3	6.2	5.2	5.3	5.4	6.0	5.7	5.8
ZPS-5LZ	5.9	7.0	6.0	6.3	5.0	5.4	4.9	5.8	6.2	6.5	7.5	4.5	6.2	5.4	5.3	7.3	6.0	5.3	4.4	3.4	8.3	6.3	5.2	5.7	5.5	5.8	5.8	5.8
OFI-931	5.6	6.6	5.6	5.3	5.4	5.1	5.0	6.3	6.4	6.6	7.6	5.1	6.7	5.7	5.2	6.8	6.2	4.4	5.1	3.9	7.9	6.3	5.3	5.4	5.7	6.0	5.8	5.8
CU9501T	5.5	6.6	5.8	5.3	5.7	5.6	4.9	6.1	6.0	6.4	8.0	5.5	6.3	5.7	5.5	6.8	6.1	4.5	4.8	3.6	8.0	6.4	5.8	5.0	5.6	5.9	5.6	5.8
* GENESIS	5.6	6.6	5.5	5.8	5.6	5.3	5.2	6.3	6.0	6.8	7.7	5.3	5.9	5.8	6.3	5.4	4.8	4.2	4.4	7.3	6.4	5.4	5.3	6.3	6.0	5.7	5.8	5.8
BAR FA6D USA	5.1	6.4	5.8	5.7	5.8	4.9	5.2	5.8	6.5	6.8	7.7	5.2	6.3	5.8	5.5	6.9	6.3	5.3	4.6	2.9	7.8	6.6	5.3	5.4	5.4	5.9	5.9	5.8
* PIXIE E+	5.3	6.6	5.1	5.7	5.6	5.9	4.9	6.9	6.0	6.6	7.2	5.5	6.1	6.1	5.7	6.5	6.0	3.9	4.5	3.9	7.6	6.4	5.8	5.0	6.0	6.0	5.9	5.8
* BONSAI 2000 (BULLET)	5.2	6.8	5.8	5.4	5.5	5.5	5.7	7.3	6.1	6.8	7.7	4.7	5.7	5.6	5.3	6.2	6.0	5.0	5.5	3.7	7.7	6.4	5.4	5.2	5.0	5.8	5.5	5.8
* BRANDY (J-101)	5.8	6.7	5.7	5.0	5.2	5.4	4.9	6.7	6.1	6.7	7.4	4.2	6.5	6.3	5.5	6.7	6.1	5.2	4.7	4.2	7.9	6.3	5.6	4.9	5.3	6.0	5.6	5.8
BAR FA 6D	5.7	6.7	6.0	6.3	5.4	5.0	4.8	5.2	6.5	6.6	7.3	5.2	6.1	6.4	5.5	6.0	6.2	4.9	4.9	3.9	7.8	6.3	5.3	5.6	4.9	5.8	5.9	5.8
MB 28	5.9	6.3	5.8	5.3	5.8	5.9	4.9	5.7	5.8	6.8	7.3	4.6	6.2	6.3	5.8	6.7	5.7	4.5	4.4	4.6	7.3	6.3	5.8	5.3	5.5	5.9	6.0	5.8
* RESERVE (ATF-182)	6.0	6.4	5.8	4.8	6.5	4.5	5.0	7.5	6.0	6.6	7.5	5.0	6.1	5.8	5.3	6.0	5.9	4.2	4.9	4.3	7.8	6.4	5.6	4.9	6.1	5.9	5.7	5.8
* RENEGADE	5.4	6.6	5.7	6.6	5.8	6.3	5.1	6.1	5.8	6.6	7.6	5.4	6.2	5.9	5.5	6.3	5.9	3.6	4.1	4.4	7.7	6.4	5.2	4.4	6.0	6.0	5.5	5.8
MB 215	5.9	6.3	5.7	6.2	5.3	5.1	4.6	5.6	5.9	6.5	7.3	4.6	6.6	6.2	6.0	7.2	6.2	4.5	4.0	3.3	7.9	6.3	5.6	5.4	6.1	5.7	6.0	5.8
* EMPRESS	5.3	6.8	5.5	5.8	5.8	5.3	5.7	6.2	6.3	6.5	7.6	5.0	5.4	5.6	5.6	6.2	6.6	4.9	5.2	3.0	7.9	6.1	5.2	5.3	5.4	5.8	5.7	5.8
BAR FA6 US3	5.6	6.4	5.9	5.3	5.0	4.8	5.1	5.9	6.4	6.6	7.8	4.1	5.9	5.5	5.8	6.9	6.4	4.6	5.2	4.3	7.8	6.7	5.3	5.2	5.0	6.0	6.1	5.8
* BRAVO (RG-93)	5.4	6.7	5.8	6.1	5.8	5.1	5.1	6.4	6.2	6.8	7.3	4.7	5.9	5.8	5.6	6.8	4.9	4.5	5.0	4.4	7.6	6.0	5.2	4.8	5.7	6.1	5.9	5.8
MB 216	5.7	6.4	5.6	5.1	5.5	5.8	4.7	5.5	5.8	6.6	7.5	4.4	6.7	6.4	5.8	7.1	5.8	4.7	4.1	3.6	7.8	6.3	5.8	5.3	5.6	5.8	6.0	5.8

**Proceedings of the UCR Turfgrass and Landscape Management Research Conference and Field Day, September 1999**

TABLE 1. (CONT'D)

MEAN TURFGRASS QUALITY RATINGS OF TALL FESCUE CULTIVARS  
GROWN IN FULL SUN AT TWENTY-SEVEN LOCATIONS IN THE U.S.  
1998 DATA

TURFGRASS QUALITY RATINGS 1-9; 9=IDEAL TURF

NAME	ARI	CA1	CA3	DE1	GA1	IA1	IL1	IL2	IN1	KS2	KY1	MD1	ME1	MI1	MO1	MO3	NE1	NJ1	NJ2	NY1	OH1	OK1	SC2	UT1	VA1	VA4	WA1	MEAN
R5AU	6.0	6.8	5.7	5.7	6.1	5.2	5.0	7.3	6.1	6.5	7.4	4.4	6.2	6.3	5.7	6.8	5.3	3.8	4.8	2.3	7.3	6.3	5.6	5.6	5.8	5.8	5.6	5.8
BAR FA6 US2U	5.9	6.5	5.9	5.6	4.9	4.9	5.1	5.7	6.3	6.7	7.5	4.7	6.1	5.8	5.7	6.5	5.9	4.5	4.8	4.2	7.7	6.0	5.3	6.3	5.3	5.9	6.0	5.8
MB 210	5.6	6.5	5.9	5.3	5.3	4.7	5.0	6.3	5.9	7.0	7.5	5.0	6.6	5.9	5.7	6.5	5.9	4.1	4.3	3.9	7.7	6.2	5.9	6.1	5.3	5.9	5.4	5.7
ISI-TF11	5.9	6.5	5.4	5.1	5.7	5.8	5.9	6.2	5.8	6.6	7.3	4.7	5.5	5.8	5.3	6.3	5.7	4.5	5.0	3.8	7.5	6.3	5.3	5.2	5.9	6.0	5.6	5.7
* SHENANDOAH	5.7	6.3	5.2	6.6	5.8	5.6	5.6	6.5	5.9	6.8	7.3	5.6	5.6	6.2	5.3	5.8	5.9	4.2	4.4	4.4	7.4	6.2	5.3	4.8	5.9	5.7	5.1	5.7
* TULSA	5.9	6.8	5.8	5.7	6.2	5.6	5.2	6.6	5.9	6.6	6.9	4.5	5.3	6.1	5.8	6.4	5.9	3.8	4.9	2.8	8.2	6.3	5.6	5.5	5.2	5.8	5.7	5.7
* REBEL 2000 (AA-989)	5.7	6.6	5.7	4.9	5.7	5.3	4.5	5.6	5.9	6.7	7.2	5.2	6.7	5.6	5.8	6.5	6.0	4.6	4.0	4.2	7.7	5.9	5.7	5.2	6.0	5.9	6.2	5.7
* RED COAT (ATF-038)	6.4	6.6	5.9	6.6	5.1	5.2	4.5	6.3	6.2	6.4	7.6	4.4	5.7	6.3	5.7	6.3	6.6	3.2	4.2	4.3	7.8	6.4	5.6	4.8	5.8	5.4	5.6	5.7
* CHAPEL HILL (TA-7)	5.6	6.3	5.6	5.2	5.6	4.8	5.0	6.3	5.8	6.5	7.8	4.9	6.2	6.4	5.9	6.3	5.9	4.5	4.3	3.9	7.6	6.2	5.3	5.3	6.1	5.9	5.7	5.7
* SAFARI	5.3	6.8	5.3	6.6	5.9	5.4	5.8	6.5	5.6	6.6	7.2	5.3	6.2	6.5	5.3	6.0	5.5	4.1	4.4	4.2	7.8	6.3	5.1	4.3	5.9	5.9	5.1	5.7
MB 214	5.9	6.8	5.7	5.4	5.0	5.0	4.5	5.5	5.8	6.5	7.6	4.8	6.1	5.8	5.4	7.0	5.9	4.7	4.1	4.4	8.1	6.0	5.6	5.2	5.8	5.6	6.1	5.7
* ARID 2 (J-3)	5.4	6.5	5.7	6.6	5.4	4.3	5.1	6.1	5.8	6.5	7.3	4.6	5.7	6.3	5.4	6.5	6.3	4.9	4.6	4.2	7.8	5.7	5.6	5.6	5.2	5.7	5.7	5.7
ATF-196	5.9	6.9	5.8	4.4	5.9	4.9	4.9	7.5	6.1	6.4	6.9	4.8	4.8	5.2	5.3	6.8	6.6	4.5	5.6	4.1	7.8	6.2	5.4	4.9	5.3	5.6	5.9	5.7
BAR FA 6LV	5.3	6.7	6.0	6.1	5.6	4.9	4.7	5.8	6.4	6.7	7.6	4.9	6.3	5.7	5.1	6.2	6.3	4.7	4.6	3.7	8.0	6.0	5.2	5.4	5.1	5.6	5.7	5.7
* CORONADO	5.2	6.7	5.7	4.9	6.0	5.3	5.0	5.8	6.1	6.8	7.0	3.8	5.8	5.5	6.2	6.5	5.9	5.9	5.1	3.0	7.8	6.1	5.4	5.9	5.4	5.7	5.7	5.7
* SUNPRO	5.8	6.7	5.8	6.3	4.4	4.6	5.0	5.0	6.3	6.5	7.1	4.8	6.2	5.6	5.5	6.3	6.4	5.4	4.8	3.6	7.9	6.2	5.3	5.8	5.2	5.7	6.0	5.7
* ANTHEM II (TMI-FMN)	5.3	7.1	5.9	4.7	5.5	5.3	5.1	6.4	5.8	6.6	7.5	4.1	5.6	6.4	5.5	6.1	5.7	5.0	4.8	3.7	7.4	6.3	5.4	6.2	5.0	6.1	5.6	5.7
* APACHE II	6.0	6.6	5.8	5.6	5.7	5.0	5.2	5.6	6.2	6.6	7.5	5.0	6.2	5.6	5.3	6.0	5.9	4.4	5.3	3.8	7.2	6.1	5.6	4.8	5.6	5.9	5.6	5.7
* AZTEC II (TMI-AZ)	4.7	6.8	5.7	5.7	5.3	5.5	5.4	6.0	6.0	6.7	7.3	3.8	5.4	6.4	5.5	6.5	5.8	5.0	5.3	4.1	8.0	6.1	5.3	4.6	5.1	6.1	5.6	5.7
ATF-257	6.4	6.8	4.9	5.3	5.7	4.8	5.8	6.7	5.7	6.7	7.6	4.6	6.1	6.0	5.5	5.9	6.6	3.9	5.1	3.5	7.5	6.1	5.4	4.7	5.6	5.7	5.3	5.7
ATF-188	5.5	6.7	5.7	5.8	5.4	4.9	5.0	6.4	6.6	6.7	7.4	4.3	5.6	6.3	4.9	6.0	5.9	4.5	5.1	3.9	7.9	6.4	5.3	4.7	5.3	5.7	5.7	5.7
BAR FA6 US1	5.7	6.6	5.6	5.7	5.1	4.4	4.5	5.4	6.5	6.6	7.3	4.8	6.2	5.6	5.5	6.7	6.4	5.1	4.5	4.3	8.3	6.3	5.3	5.3	4.3	5.6	5.9	5.7
ISI-TF9	5.9	6.6	5.5	5.7	5.4	4.8	5.2	6.5	5.9	6.5	7.7	4.4	6.0	6.1	5.3	6.1	6.2	4.6	4.7	3.7	7.3	6.5	5.3	4.6	5.5	5.9	5.5	5.7
OFI-96-31	5.5	6.6	5.8	5.9	5.1	4.9	4.9	4.8	6.1	6.7	6.9	4.2	5.8	5.9	5.5	6.7	6.0	4.8	5.2	4.3	7.8	6.4	5.3	5.4	5.5	5.8	5.8	5.7
SRX 8500	5.4	6.8	5.8	5.1	4.5	4.8	5.0	5.8	6.3	6.8	7.7	4.6	5.9	5.9	5.7	6.3	6.8	4.3	5.0	3.7	7.4	6.5	5.2	5.2	5.0	5.8	5.8	5.7
* DUSTER	5.2	6.7	5.6	5.2	5.3	5.6	5.1	6.2	6.0	6.6	7.1	4.9	5.9	5.8	5.3	6.4	5.9	4.3	4.6	3.9	7.5	6.4	5.1	5.6	5.5	5.7	5.6	5.7
* BULLDAWG (PICK GA-96)	5.5	6.6	5.4	5.2	5.2	4.3	5.3	5.3	6.2	6.5	7.5	4.6	6.2	5.5	5.4	6.3	5.9	5.4	4.9	4.4	7.5	6.2	5.2	4.9	5.6	6.0	5.7	5.7
PST-5TO	5.9	6.6	5.7	4.8	6.2	4.2	5.2	6.0	6.1	6.8	7.5	4.4	5.1	6.1	5.8	6.4	5.1	5.3	5.2	3.2	7.8	6.3	5.2	5.1	5.4	6.0	5.7	5.7
* TWILIGHT II (TMI-TW)	5.2	6.7	5.6	5.6	5.5	5.2	5.0	6.2	5.7	6.7	7.1	4.4	5.1	6.2	5.6	7.0	5.3	5.3	4.5	3.7	7.2	6.5	5.2	5.3	5.5	6.0	5.8	5.7
* CORONADO GOLD (PST-5RT)	6.2	6.4	6.0	5.2	6.6	4.8	5.3	5.2	6.0	6.7	7.0	3.7	5.9	5.9	5.6	6.4	5.1	5.5	5.1	2.9	7.7	6.4	5.2	4.7	5.7	6.0	5.7	5.7
* BANDANA (PST-R5AE)	5.2	6.7	5.7	5.4	5.6	5.4	5.4	6.4	5.9	6.6	7.1	5.1	5.0	6.2	5.6	6.2	5.4	4.1	4.5	3.6	7.7	6.6	5.2	4.4	5.7	6.1	5.6	5.6
PRO 8430	5.3	6.6	5.6	5.2	5.6	5.3	5.7	6.6	6.0	6.7	7.0	4.3	5.8	5.7	5.5	6.0	6.2	3.8	4.7	3.7	7.7	6.2	5.1	5.0	5.6	5.8	5.5	5.6
* REGIMENT	5.1	6.6	5.5	6.1	5.2	5.8	5.4	6.1	6.1	6.4	6.5	5.0	5.7	6.0	5.5	6.1	5.7	4.2	4.4	3.7	7.6	6.1	5.6	4.4	5.8	6.0	5.5	5.6
* VELOCITY (AA-983)	5.9	6.3	5.7	5.2	5.7	3.9	4.8	6.2	6.0	6.5	7.1	4.6	6.3	6.0	5.5	7.0	6.6	3.8	4.0	3.3	7.8	6.3	5.6	4.9	5.6	5.7	5.9	5.6
* ALAMO E	6.0	6.6	5.7	5.0	5.3	5.2	5.3	5.9	6.0	6.5	7.0	4.6	5.3	6.3	5.3	6.2	5.5	4.8	5.2	3.2	7.9	6.3	5.6	4.7	5.1	5.6	5.8	5.6
SR 8210	5.8	6.7	5.8	5.1	5.0	5.2	5.0	5.0	6.5	6.7	7.0	4.0	5.3	6.2	5.3	6.4	5.7	4.6	5.1	3.8	8.0	6.1	5.0	5.4	5.2	6.0	5.5	5.6
* LION	6.5	6.4	5.9	4.5	4.4	5.0	5.3	6.3	5.7	6.5	7.3	4.8	5.9	6.2	5.6	6.8	5.7	4.5	4.4	2.7	7.8	6.4	5.3	4.6	5.4	6.0	5.6	5.6
WX3-275	5.2	6.6	5.5	5.1	5.8	5.4	5.2	5.8	5.9	6.4	7.3	3.9	6.0	5.8	5.3	6.0	5.9	5.0	4.4	4.5	7.4	6.1	5.2	4.7	5.4	5.7	5.5	5.6
OFI-951	5.6	6.5	6.0	5.4	4.7	4.7	4.8	5.0	6.4	6.5	7.4	4.7	4.9	6.0	5.5	6.7	6.1	4.4	5.0	3.8	7.8	6.2	5.2	5.4	4.7	5.8	5.9	5.6
ATF-253	5.7	6.7	5.4	5.6	5.7	5.1	5.7	7.0	5.7	6.5	7.2	3.8	5.9	5.7	5.6	6.3	5.5	4.6	4.8	2.6	7.3	6.4	5.3	4.1	5.6	5.6	5.7	5.6
PICK FA XK-95	5.9	6.9	5.7	5.1	5.0	4.8	5.1	5.5	6.5	6.5	7.3	3.7	4.9	5.3	5.6	6.4	6.0	5.0	5.3	3.7	7.6	6.3	5.2	4.4	5.5	5.7	5.8	5.6
BAR FA6 US6F	5.3	6.5	5.5	5.7	5.2	5.3	5.1	5.2	6.0	6.4	7.0	4.6	5.7	5.8	5.8	6.5	5.6	4.2	4.6	2.3	7.8	6.4	5.1	5.8	5.5	6.0	5.8	5.6
OFI-FWY	6.0	6.6	5.0	5.2	4.9	4.9	5.0	5.2	6.3	6.5	7.2	4.4	5.7	5.6	5.7	5.8	6.2	4.3	4.5	3.8	7.4	6.4	5.1	5.7	5.6	5.8	5.7	5.6
* MARKSMAN	5.3	6.5	5.2	6.0	5.6	5.6	5.3	5.5	5.7	6.8	6.8	4.0	6.3	6.1	5.4	5.7	6.2	3.7	4.5	3.3	7.8	6.3	5.6	4.8	5.3	6.0	5.5	5.6
* ARABIA (J-5)	5.7	6.6	5.9	5.6	4.4	4.6	4.8	5.4	6.4	6.1	7.5	4.0	5.7	5.5	5.6	6.7	5.3	4.8	4.2	3.8	7.3	6.1	5.4	6.1	4.9	5.9	6.1	5.6

Proceedings of the UCR Turfgrass and Landscape Management Research Conference and Field Day, September 1999

TABLE 1. (CONT'D)

MEAN TURFGRASS QUALITY RATINGS OF TALL FESCUE CULTIVARS  
GROWN IN FULL SUN AT TWENTY-SEVEN LOCATIONS IN THE U.S.  
1998 DATA  
TURFGRASS QUALITY RATINGS 1-9; 9=IDEAL TURF

NAME	AR1	CA1	CA3	DE1	GA1	IA1	IL1	IL2	IN1	KS2	KY1	MD1	ME1	MI1	MO1	MO3	NE1	NJ1	NJ2	NY1	OH1	OK1	SC2	UT1	VA1	VA4	WA1	MEAN
* FINELAWN PETITE	5.0	6.6	5.7	4.8	5.7	5.6	5.0	5.5	5.8	6.5	7.0	4.6	5.9	5.3	5.6	5.9	5.5	4.2	4.1	3.7	7.8	6.4	5.3	5.8	5.6	5.8	5.7	5.6
PICK FA 20-92	5.0	6.8	5.8	4.7	5.0	4.6	5.2	5.0	6.4	6.0	7.6	4.7	6.2	5.1	5.4	6.7	6.1	4.5	5.4	4.1	7.6	6.4	5.1	4.6	4.9	5.4	6.0	5.6
ATF-022	5.8	6.4	5.2	4.8	5.7	5.0	4.9	7.0	5.7	6.5	7.1	4.3	6.1	5.8	5.4	6.0	5.8	3.5	4.6	3.9	7.5	6.2	5.4	4.8	5.7	5.3	5.5	5.6
* FALCON II	4.9	6.6	5.5	5.1	5.8	5.1	5.1	5.1	5.8	6.7	7.1	5.3	6.0	6.0	5.4	5.8	5.9	3.9	4.1	3.7	7.3	6.1	5.2	5.2	5.6	5.9	5.6	5.6
ISI-TF10	5.9	6.5	5.9	5.6	5.0	4.5	4.9	4.8	5.9	6.4	7.7	4.1	5.9	6.3	5.7	6.2	5.1	4.5	4.1	3.9	7.4	6.5	5.2	5.3	5.5	5.3	5.8	5.6
* TITAN 2	5.4	6.3	4.9	5.7	5.5	6.2	5.5	5.6	5.5	6.6	6.5	5.3	5.8	6.0	5.4	5.6	5.7	3.8	4.7	4.4	7.3	6.1	5.4	4.4	5.7	5.5	5.0	5.5
* TOMAHAWK-E	4.8	6.6	5.5	5.3	5.3	4.6	5.3	5.6	5.9	6.5	6.8	4.1	6.8	6.1	5.2	6.1	6.5	4.3	4.0	3.8	7.5	6.0	5.2	4.9	5.5	5.6	5.8	5.5
OFI-96-32	5.6	6.6	5.5	5.3	5.9	5.3	5.1	6.0	5.8	6.5	6.7	4.1	5.0	5.9	5.5	6.2	5.2	3.9	4.2	3.7	7.6	6.3	5.4	4.8	5.9	5.6	5.6	5.5
EA 41	5.8	6.5	5.7	5.3	3.8	4.9	5.0	5.0	6.0	6.2	7.2	5.0	5.5	6.0	5.9	6.6	5.6	4.6	4.9	2.8	7.8	6.2	5.0	4.7	5.4	5.7	6.0	5.5
* COCHISE II	6.2	6.7	5.5	5.1	5.0	4.9	5.0	5.6	6.1	6.4	6.5	4.7	5.1	5.4	5.6	6.2	5.8	3.9	4.8	4.3	8.0	6.4	5.2	4.1	5.2	5.5	5.7	5.5
* GOOD-EN (KOOS 96-14)	5.1	6.5	5.4	4.5	4.9	4.7	5.4	5.8	5.7	6.6	6.8	4.6	6.2	5.9	5.3	6.0	5.6	4.3	4.3	3.9	7.5	6.3	5.2	4.9	5.9	5.7	5.7	5.5
SRX 8084	5.1	6.6	5.5	6.3	5.3	5.2	5.2	5.5	5.8	6.4	7.3	4.4	5.4	6.2	5.3	6.0	5.8	3.8	4.5	3.1	7.6	6.1	5.0	4.7	5.6	5.9	5.2	5.5
ATF-020	5.9	6.4	5.4	5.1	5.1	4.6	5.0	6.4	5.5	6.4	7.4	4.4	6.2	5.8	5.0	6.3	5.8	3.6	4.3	3.4	7.4	6.1	5.4	4.8	5.2	5.5	5.7	5.5
PSII-TF-9	5.4	6.4	5.1	6.0	5.6	5.3	5.0	5.6	5.8	6.3	7.0	4.7	5.1	6.1	5.4	6.0	5.3	3.7	4.4	4.3	7.2	6.3	5.3	4.4	5.6	5.4	5.4	5.5
* PICK FA 6-91	5.7	6.5	5.2	5.0	5.3	4.4	4.9	5.5	6.0	6.5	6.8	4.6	5.7	5.2	5.7	6.7	6.4	4.4	4.3	2.3	7.5	6.3	5.6	5.1	4.6	5.6	6.0	5.5
PICK FA 15-92	5.7	6.9	5.7	6.0	4.8	4.7	4.6	5.3	6.1	6.4	7.1	3.9	4.9	5.6	5.3	6.4	5.9	5.3	4.4	3.6	7.2	5.6	5.6	4.8	4.7	5.2	5.9	5.5
* PEDESTAL (PC-AO)	5.0	6.5	5.2	5.2	5.1	4.9	4.8	5.5	5.9	6.7	7.7	4.0	5.3	6.1	5.1	6.4	5.9	3.8	4.5	3.7	7.4	6.0	5.3	4.2	5.8	5.7	5.5	5.5
EC-101	5.0	6.6	5.7	5.0	5.4	4.5	4.9	5.3	5.8	6.5	7.3	3.8	5.6	6.4	5.4	6.3	5.8	3.9	4.0	3.2	7.7	6.2	5.3	4.8	5.5	5.8	5.5	5.5
* LEPRECHAUN	5.0	6.5	5.6	4.8	5.9	5.4	5.3	4.8	6.0	6.5	6.9	5.1	5.9	5.7	5.2	5.8	5.4	3.9	3.7	4.1	7.3	6.1	5.1	4.7	5.4	5.5	5.6	5.5
* COMSTOCK (SSDE31)	5.7	6.3	5.4	5.7	5.2	4.6	5.1	5.1	5.6	6.5	7.0	4.4	6.1	6.3	5.4	5.6	5.4	4.0	4.0	2.6	7.4	6.2	5.4	4.6	6.3	5.6	5.6	5.5
WVPB-1D	5.4	6.6	5.2	6.0	5.8	5.3	4.8	5.2	5.7	6.5	6.7	4.3	4.9	6.1	5.3	6.2	5.7	3.8	4.2	3.7	7.3	6.4	5.2	4.0	5.8	5.6	5.5	5.4
WVPB-1B	5.3	6.4	5.2	5.3	5.5	5.0	5.1	5.6	5.8	6.4	6.9	4.7	5.8	5.9	5.2	6.1	5.2	4.2	4.0	3.4	7.4	6.1	5.1	4.9	5.8	5.4	5.4	5.4
PICK FA N-93	5.1	6.5	5.7	4.8	3.9	4.2	5.0	5.4	6.5	6.5	7.0	4.2	5.3	4.9	5.1	6.7	5.8	5.3	5.4	3.3	7.9	6.4	5.2	5.0	4.2	5.4	6.0	5.4
* SHORTSTOP II	5.0	6.6	5.8	4.9	3.9	5.1	4.9	5.2	6.2	6.4	6.7	5.1	4.2	4.9	5.6	6.3	6.2	5.1	4.4	4.2	7.6	6.0	5.6	5.1	4.6	5.6	5.7	5.4
* KITTY HAWK S.S.T. (SS45DW)	4.7	6.4	5.2	5.4	5.3	4.8	5.7	5.6	5.8	6.6	6.8	3.9	5.4	5.9	5.2	6.0	5.2	3.8	4.6	3.9	7.5	6.1	5.4	4.6	5.6	5.7	5.5	5.4
* WPEZE (WVPB-1C)	5.0	6.5	5.2	5.1	5.4	5.1	5.0	5.5	5.8	6.4	6.9	4.8	5.2	5.9	5.4	5.9	5.1	3.3	4.3	4.2	7.4	6.1	5.3	4.8	6.0	5.7	5.4	5.4
PSII-TF-10	5.1	6.4	5.1	5.0	5.0	5.3	5.1	5.2	5.7	6.5	7.3	4.0	5.1	5.8	5.5	6.2	6.0	4.0	3.9	3.8	7.3	6.3	5.2	4.4	5.8	5.6	5.6	5.4
* EQUINOX (TMI-N91)	5.0	6.7	5.5	5.7	5.5	4.3	5.4	5.1	5.5	6.4	6.5	4.6	5.7	6.1	5.4	5.7	4.4	4.1	4.5	3.3	7.2	6.1	5.4	4.8	5.3	5.7	5.6	5.4
AXIOM (ATF-192)	5.3	6.4	5.5	5.3	5.5	4.9	4.9	5.5	5.5	6.5	6.8	4.1	5.4	5.9	5.3	5.7	4.9	3.5	4.3	3.4	6.7	6.0	5.6	5.3	5.4	5.6	5.4	5.4
DP 50-9011	5.3	6.9	5.3	5.6	4.6	4.3	4.6	4.5	6.0	6.1	6.7	4.7	5.1	6.2	5.1	6.0	5.6	3.6	3.7	4.1	7.6	6.0	5.3	4.9	4.7	5.3	5.3	5.3
JTTFC-96	5.3	6.3	5.0	5.7	5.4	5.1	4.9	5.3	5.6	6.4	6.9	4.4	5.5	6.4	5.5	5.6	5.2	3.3	4.0	3.3	6.8	6.4	5.0	3.9	5.3	5.4	4.7	5.3
* BONSAI	4.8	6.4	5.5	5.7	3.1	4.7	4.8	5.3	5.8	6.5	6.6	3.9	5.1	6.3	5.5	5.8	5.8	3.7	4.3	3.6	7.3	6.3	5.3	4.2	5.3	5.4	5.6	5.3
JSC-1	4.8	6.3	4.9	4.8	4.9	5.2	5.0	4.0	5.5	6.4	7.0	3.9	5.2	6.1	5.0	5.9	5.7	3.4	3.5	3.6	7.3	5.8	5.3	4.4	5.6	5.3	5.4	5.2
JTTFA-96	5.0	6.1	4.7	5.7	5.5	5.1	5.0	4.7	5.7	5.9	6.1	5.5	5.1	6.1	4.9	5.3	4.6	2.9	4.4	3.7	7.3	6.2	5.0	4.5	5.0	5.3	4.7	5.2
PICK FA UT-93	5.3	6.6	5.2	4.8	3.6	4.2	4.4	3.8	6.3	5.8	6.9	3.8	4.8	4.3	4.9	6.4	5.7	4.7	4.5	3.6	7.8	5.9	5.2	5.7	4.0	5.2	5.6	5.1
DLF-1	5.1	5.9	4.5	5.4	4.9	4.9	4.6	4.4	5.3	6.5	6.0	4.0	4.9	6.2	5.0	5.3	5.2	2.8	3.2	2.3	7.1	6.1	5.6	4.3	5.4	5.1	4.9	5.0
* ARID	4.7	5.8	4.7	4.2	5.4	6.1	4.6	4.8	5.1	5.9	6.5	4.9	4.2	6.3	5.3	4.9	5.4	2.8	2.8	3.2	7.0	6.0	5.4	4.3	5.2	5.0	4.6	5.0
DP 7952	4.4	5.6	4.4	4.7	3.5	5.3	4.6	4.1	5.2	6.4	6.3	5.0	4.9	6.1	5.0	5.4	4.4	2.5	3.2	4.1	7.2	5.6	5.3	4.3	4.7	5.0	4.5	4.9
AV-1	4.3	5.1	4.3	5.2	4.9	4.9	4.8	3.2	4.9	6.2	5.7	3.9	5.1	6.2	4.7	5.1	4.6	2.3	3.0	2.6	6.6	5.3	5.4	3.8	5.4	5.0	4.9	4.7
* KENTUCKY-31 W/ENDO.	3.5	3.1	4.0	4.0	5.1	5.9	3.9	2.6	3.3	4.7	3.7	3.6	3.4	6.6	4.7	3.5	2.8	1.8	1.1	3.3	5.2	5.2	4.7	3.6	4.0	4.0	3.5	3.9
LSL VALUE	0.9	0.3	0.5	1.4	1.2	1.3	0.7	1.5	0.4	0.4	0.6	1.1	1.2	0.8	0.6	0.6	0.7	1.0	0.7	1.3	0.6	0.7	1.2	1.1	0.8	0.5	0.4	0.2
C.V. (%)	10.6	3.2	5.6	15.9	12.7	15.6	8.5	15.3	4.1	3.9	5.2	15.4	12.5	8.4	6.7	5.4	8.0	14.3	9.1	22.7	4.7	6.9	13.5	13.8	8.7	5.8	4.1	9.8

\* COMMERCIALY AVAILABLE IN THE USA IN 1999.

1/ TO DETERMINE STATISTICAL DIFFERENCES AMONG ENTRIES, SUBTRACT ONE ENTRY'S MEAN FROM ANOTHER ENTRY'S MEAN. STATISTICAL DIFFERENCES OCCUR WHEN THIS VALUE IS LARGER THAN THE CORRESPONDING LSD VALUE (LSD 0.05).

2/ C.V. (COEFFICIENT OF VARIATION) INDICATES THE PERCENT VARIATION OF THE MEAN IN EACH COLUMN.

# **LANDSCAPE MANAGEMENT RESEARCH CONFERENCE AND FIELD DAY**

**WEDNESDAY, SEPTEMBER 15, 1999**

**SPONSORED BY:**

**UNIVERSITY OF CALIFORNIA COOPERATIVE EXTENSION**



**UNIVERSITY OF CALIFORNIA, RIVERSIDE, DEPT. OF BOTANY & PLANT SCIENCES**

**UNIVERSITY OF CALIFORNIA, RIVERSIDE, AGRICULTURAL OPERATIONS**

**CALIFORNIA LANDSCAPE CONTRACTORS ASSOCIATION**





**LANDSCAPE MANAGEMENT RESEARCH CONFERENCE AND FIELD DAY  
SEPTEMBER 15, 1999**

**TABLE OF CONTENTS AND CONFERENCE SCHEDULE**

<b>8:00 a.m.</b>	<b>Registration</b>	
<b>8:40</b>	<b>Welcome and Announcements</b> <i>Cheryl Wilen</i>	
<b>8:50</b>	<b>Effects of Root Barriers on Tree and Root Growth</b> .....	<b>1</b>
	<i>Dennis Pittenger</i>	
<b>9:10</b>	<b>Impact of Container Size on Future Growth Rates of Landscape Trees</b> .....	<b>3</b>
	<i>Janet Hartin</i>	
<b>9:30</b>	<b>Biology of the Red Imported Fire Ant and Its Management in the Landscape</b> .....	<b>4</b>
	<i>Les Greenberg</i>	
<b>10:20</b>	<b><i>BREAK</i></b>	
<b>10:40</b>	<b>New Insect Pests of Eucalyptus: Lerp Psyllid and Tortoise Beetle</b> .....	<b>6</b>
	<i>Mark Hoddle</i>	
<b>11:10</b>	<b>Artichoke Thistle - An Invader in the California Landscape</b> .....	<b>7</b>
	<i>Virginia White</i>	
<b>11:30</b>	<b>Update on the Africanized Honey Bee Situation</b> .....	<b>8</b>
	<i>Karen Robb</i>	
<b>12 noon</b>	<b><i>LUNCH</i></b>	
<b>12:45 p.m.</b>	<b>Drive Your Own Car to Agricultural Experiment Station</b>	
<b>1:20</b>	<b>Organizational Comments</b>	
<b>Stop #1</b>	<b>Performance of Landscape Weed Barriers</b> .....	<b>10</b>
	<i>Cheryl Wilen</i>	
<b>Stop #2</b>	<b>Technologies for Measuring Soil Water Content</b> .....	<b>13</b>
	<i>Laosheng Wu and William Richie</i>	
<b>Stop #3</b>	<b>Update on Precision Pesticide Application in the Landscape</b> .....	<b>14</b>
	<i>David Shaw</i>	
<b>Stop #4</b>	<b>Landscape Weed Identification</b> .....	<b>15</b>
	<i>David Cudney</i>	
<b>Stop #5</b>	<b>Evaluation of Landscape Tree Species</b> .....	<b>17</b>
	<i>Donald Hodel</i>	

## EFFECTS OF ROOT BARRIERS ON TREE AND ROOT GROWTH

Dennis R. Pittenger<sup>1,2</sup> and Donald R. Hodel<sup>2</sup>

<sup>1</sup>University of California Cooperative Extension, Southern Region

Dept. of Botany and Plant Sciences, University of California, Riverside, CA 92521-0124

<sup>2</sup>University of California Cooperative Extension, Los Angeles County

2 Coral Circle, Monterey Park, CA 91755

Millions of dollars are spent annually to repair pavement and other hardscape items broken or lifted by tree roots. When too little urban space is allocated for tree root systems to grow and develop naturally, damage to nearby man-made infrastructure can be expected. Installation of surround-type root barriers is often specified as a means of preventing damage from future root growth when new street or parking lot trees are planted. While completely surrounding a newly-planted tree's rootball with a root barrier may appear to be the ideal solution in these root-space limited sites, the evidence for their effectiveness is largely observational and anecdotal. Research-based information on the effectiveness of tree root barriers is very limited. The previous field research conducted on root barriers has shown that roots grow out the bottom of the barrier and return to the upper several inches of soil where air and water are more consistently available. The distance from the trunk at which the roots return to the surface is variable and dependent on several factors. The study reported here was designed to further determine the influence of various types of physical surround-type root barriers on surface root development and tree growth.

The 6-year study was established in June 1992 at UC Riverside and completed in August 1998 with excavation of root systems to collect root number data. Two tree species, *Liquidambar styraciflua* and *Ficus nitida*, were transplanted as 5-gallon plants into the field site at a 20 ft. x 20 ft. spacing and kept well-watered throughout the study. Root barrier treatments were:

1. 'DeepRoot' barrier (DeepRoot Partners, L. P.) 30 in. diameter x 24 in. deep.
2. Standard 15-gallon nursery container with the bottom removed (14 in. top diameter x 12.5 in. bottom diameter x 17 in. height).
3. Black polyethylene (12 mil) sleeve the same dimensions as a 15-gallon container.
4. Standard 5-gallon nursery container with the bottom removed (10 in. top diam. x 8 in. bottom diam. x 12 in. height).
5. Check: Standard transplanting of 5-gallon tree so that the surface of the root ball is at the field soil level.

Data collected and analyzed were tree growth (caliper and height) plus the number of roots in each of three size classes (0.5-1 in., 1-2 in., >2 in. diameter) distributed in 5 distance zones from the trunk to a 6.0 ft. radius and to a 6.0 in. depth. Roots were observed to grow out of the bottom of each of the barrier configurations tested, and return in reduced numbers to the excavated area. All root barrier treatments were effective in reducing the total number of roots in the excavated area. The DeepRoot and the 15-gal barriers were equal in performance and were the most effective in reducing total number of roots. With respect to problematic large roots, all of the barrier treatments reduced their number in the surface soil, but no barrier elimi-

nated all of them in all distance zones. Barrier treatments varied mostly in how well and how far from the trunk they reduced the number of small and medium roots. Large roots were present in very few numbers beyond 48 in from the trunk, and there was no significant effect of any barrier on their number beyond that distance.

It appears that surround-type barriers can reduce the number of surface roots that develop immediately outside the barrier, but no barrier product should be viewed as a silver bullet that eliminates surface root problems. A variety of barrier configurations appear to be effective in creating a limited zone clear of large surface roots at least a few feet from the trunk for a limited period of time after planting. Roots do return to the surface after growing out of a barrier, but many of them are relatively small and would not damage hardscape immediately.

**References:**

- Costello, L. R., E. L. Elmore, and S. Steinmaus. 1997. Tree root response to circling root barriers. *J. Arboric.* 23(6): 211-218.
- Sommer, R. and Christina L Cecchetti. 1992. Street tree location and sidewalk management preferences of urban householders. *J. Arboric.* 18(4): 188-191.
- Wagar, J. A. and P. A. Barker. Effectiveness of three barrier materials for stopping regenerating roots of established trees. *J. Arboric.* 9(6): 332-338.
- Watson, G. W. and D. Neely (eds.). 1994. *The Landscape Below Ground: Proc. of a workshop on tree root development in urban soils, The Morton Arboretum, Sept. 30 and Oct. 1, 1993.* Int'l. Soc. of Arboric.

## IMPACT OF CONTAINER SIZE ON FUTURE GROWTH RATES OF LANDSCAPE TREES

Janet Hartin<sup>1</sup> and Dennis R. Pittenger<sup>2</sup>

<sup>1</sup>University of California Cooperative Extension, San Bernardino and Los Angeles Counties  
777 E. Rialto Avenue, San Bernardino, CA 92415

<sup>2</sup>University of California Cooperative Extension, Southern Region and Los Angeles County  
Dept. of Botany and Plant Sciences, University of California, Riverside, CA 92521-0124

Fifteen *Quercus agrifolia* and fifteen *Magnolia grandiflora* container-grown trees were planted at the University of California, Riverside in June 1992. The planting is a completely random experimental design with five replications. Five trees of each species were transplanted from 5-gallon containers, five were transplanted from 15-gallon containers, and five were transplanted from 24-inch boxes directly into the field. Although recommendations have prevailed for decades suggesting that the ultimate growth of landscape trees transplanted from smaller container sizes is similar or even greater than that of trees transplanted from larger containers, little actual research has been conducted to prove or disprove this theory. This study was undertaken to gain further understanding of this issue in Southern California. The objective of the study was to determine the relationship of container size to future growth of each species.

Trees were planted on a 20 X 20 feet spacing, and irrigated based on reference evapotranspiration (ET<sub>o</sub>) from the on-site California Irrigation Management Information System (CIMIS) weather station. Soil moisture was not a limiting factor. Trees were fertilized in 1993 and 1994 at 3 lb. N/1000 ft<sup>2</sup> of drip line area. Weeds have been managed with a combination of preemergent herbicide (Surflan), hand weeding, and contact herbicide.

Semiannually, trunk circumference at six-inches above the soil level was measured. There were significant differences between trunk circumference and container size for both *Quercus* and *Magnolia*. In general, trunk circumference was positively correlated with container size throughout the study, although large variations occurred, particularly within replicated treatments of *Quercus*. Final results and implications for professional arborists and landscapers will be discussed.

<i>Magnolia: A</i>			<i>Quercus: B</i>		
24 inch box: 1		15 gallon: 2	5 gallon: 3		
<b>B1</b>	<b>A1</b>		<b>A3</b>		
<b>A2</b>	<b>B3</b>		<b>B2</b>		
<b>A3</b>	<b>B2</b>		<b>A1</b>		
<b>B1</b>	<b>A2</b>		<b>B3</b>		
<b>B3</b>	<b>B2</b>		<b>B1</b>		
<b>A1</b>	<b>A3</b>		<b>A2</b>		
<b>A1</b>	<b>A3</b>		<b>A2</b>		
<b>B3</b>	<b>B2</b>		<b>B1</b>		
<b>A3</b>	<b>B3</b>		<b>A2</b>		
<b>B2</b>	<b>B1</b>		<b>A1</b>		

## **THE RED IMPORTED FIRE ANT IN CALIFORNIA**

**Les Greenberg**

*Dept. of Entomology, University of California, Riverside, CA 92521-0124*

The Red Imported Fire Ant ('RIFA', for short), *Solenopsis invicta*, was introduced into Mobile, AL between 1930 and 1940. It then spread rapidly outward from that source and now infests all the southeastern states from Florida to Texas and north to southern Virginia, Tennessee, Oklahoma, and Arkansas. There is an outbreak in New Mexico near El Paso, and occasional outbreaks are reported from Arizona. Fire ants have been intercepted many times entering California with plants, honey bee hives, and other produce. There were several infestations in 1997 and 1998 located in almond groves that originated with honey bees from Texas that were imported to fertilize the crops. These localized infestations were in Kern, Stanislaus, and Fresno counties.

In 1998 a much wider infestation was discovered in Orange and southern Los Angeles counties. These infestations are more serious because they occur in public areas as well as in plant nurseries. Another large infestation was found in the Coachella Valley near Indio and included horse facilities, nurseries, and a sod farm. A small infestation has also been found in Moreno Valley near an elementary school.

Early efforts to control fire ants in the southeast involved aerial applications of Mirex. This product was removed from the market because of its potential build-up in the food chain. Newer products break down quickly and do not persist in the environment. Eradication in the eastern part of the ant's range is no longer considered possible; fire ant management programs now aim to reduce the ant's impact on people and wildlife. The California situation may be fundamentally different because the state is not surrounded by a sea of ants ready to move in at a moment's notice. Therefore, eradication of the known pockets of these ants is still possible.

The RIFA differs in a number of ways from our native fire ants. First, they tend to make dome-shaped mounds that are honeycombed with tunnels. Second, they are more aggressive and will run up any object touching their mound. Third, there are some morphological differences, including a black triangular mark and a third clypeal tooth on the head. All fire ants can be identified by the presence of two segments in the narrow waist (petiole) and 10-segmented antennae with a 2-segment club. All fire ants can sting. The RIFA sting causes a burning sensation followed by the development of a white pustule on the skin.

Virgin queens and male fire ants have wings. They must fly to mate. The newly-mated queens then remove their wings and burrow into the ground to start a new nest. The males die almost immediately after the mating flight.

The RIFA can cause many kinds of damage by: chewing on budding leaves and roots of young plants; attacking ground-nesting animals such as hatchlings; causing short-circuits in electrical devices; damaging farm machinery that runs over their mounds; tending aphids and scale insects on plants.

The newest products used against fire ants are baits containing insect growth regulators (IGRs). These substances sterilize the queen so that she does not lay any more eggs. Fungal

by-products called Spinosad are also reaching the market. There are several biocontrol agents now being tested. One is a phorid fly that lays its egg in the head of the ant, and eventually destroys the ant's brain. Another is a protozoan called *Thelohania* that parasitizes fire ant cells. A third is a fungus called *Beauvaria*. In theory these biocontrol agents increase the stress on fire ants so that native species of ants can compete with and perhaps displace the RIFA.

## NEW INSECT PESTS OF EUCALYPTUS: RED GUM LERP PSYLLIDS AND TORTOISE BEETLES

Mark S. Hoddle

Dept. of Entomology, University of California, Riverside, CA 92521-0124

Eucalyptus are among the most abundant ornamental, shade, and windrow trees grown in California. Species of *Eucalyptus* are valued for their fast growth, drought tolerance, capacity to grow in marginal soils, and until relatively recently, eucalyptus were attacked by few arthropod pests of economic importance. In the last two years, the red gum lerp psyllid (*Glycaspis brimblecombei* [Homoptera: Psyllidae]) and the tortoise beetle (*Trachymela sloanei* [Coleoptera: Chrysomelidae]), insect species native to Australia (the home continent of eucalyptus), have been accidentally introduced into California where they are causing significant damage to a variety of eucalyptus species.

The red gum lerp psyllid (RLP) was first discovered on *Eucalyptus camaldulensis* in Los Angeles county in June 1998. It spread quickly from the point of initial discovery and its range currently extends from San Francisco to San Diego. RLP is readily identified by small conical crystalline caps on the surface of infested leaves. These caps are referred to as lerps, and immature psyllids develop under these protective covers. Densities of RLP on leaves of susceptible eucalyptus varieties have been high enough to cause repeated defoliation of trees and in some instances tree death has occurred. There are no specialized natural enemies attacking RLP in California. Consequently, population growth of RLP in California is unregulated by biotic agents at present.

In February 1998, the eucalyptus tortoise beetle was discovered in Riverside County where it attacks *E. globulus* and *E. viminalis*. The rate of spread of this pest has been slow with beetle populations primarily located between Orange and LA counties in southern California. Overseas experiences have shown that if left unchecked species of tortoise beetles can increase rapidly increase in number and defoliate trees. Feeding by adults and larval tortoise beetles leave characteristic notches on leaf margins giving the appearance of step-like pattern. There are no known specialist natural enemies of the tortoise beetle in California and irritants secreted by larval beetles may make them unattractive as a food source for generalist predators like lacewing larvae or ladybugs. Consequently, population growth of tortoise beetles in California is unregulated by biotic agents at present.

Biological control may be the only cost effective, long-term solution for the suppression of RLP and tortoise beetles. UC entomologists are currently searching for, or evaluating, parasitic wasps for release against these pests.

## ARTICHOKE THISTLE DEVELOPMENT AND MANAGEMENT

Virginia A. White and Jodie S. Holt

Dept. of Botany and Plant Sciences, University of California, Riverside, CA 92521-0124

Historically, California grasslands have been drastically altered by both natural events and human activities. Drought, fire suppression, and grazing practices have left these grasslands vulnerable to invasive species at the expense of natives. One such invasive species is *Cynara cardunculus*, artichoke thistle. This perennial species can grow to several meters tall and produce hundreds of seeds per plant. It is found in regions with a Mediterranean climate, where precipitation is more abundant in winter. The active growing season for *C. cardunculus* is during the winter. Once established, it can exclude native grasses and most other vegetation. Management of *C. cardunculus* is necessary in order to restore these grasslands to their native vegetation or to restore their utility as rangelands. Current management practices include the use of herbicides, controlled burning and/or mechanical removal. These approaches can be costly and time consuming and *C. cardunculus* re-establishment usually occurs. A greater understanding of the biology of the plant is needed to maximize effectiveness of removal efforts.

The phenology experiment was conducted to observe emergence, growth, and development of *C. cardunculus* over 18 months. The number of days required to reach specified phenological stages (emergence, 2 - 10 leaves, bolting, 1 - 10 flowers, and seed set) was recorded. The clipping experiment was conducted to determine when plants become functionally perennial. At predetermined phenological stages, all aboveground plant matter was removed and the number of days until resprouting was recorded. In the phenology experiment, rate of rosette formation and reproductive maturity were greatly affected by month of planting. In the clipping experiment, every treatment resprouted but the number of days necessary to resprout was affected by the stage at which the plant was clipped.

As with other restoration efforts, *C. cardunculus* management will be a long-term project. *C. cardunculus* has been reported to be a biennial, not flowering until its second season. However, these experiments found that all growth stages could occur in the first year. Because each individual can reach reproductive maturity within one year, the rate at which the species can spread is greater than for a biennial species. In the experimental plots *C. cardunculus* resprouted even when clipped at the cotyledon stage. This indicates that this species may become functionally perennial almost immediately. Further study is needed to determine the physiological basis for this ability, but the implications for management are clear. *Cynara cardunculus* has the potential to become a tremendous biological and economical burden if not properly controlled.



## **UPDATE ON THE AFRICANIZED HONEY BEE SITUATION**

**Karen L. Robb**

*University of California Cooperative Extension, San Diego County  
5555 Overland Avenue, Bldg. 4, San Diego, CA 92123*

The Africanized honey bee (AHB) – also called “killer bee” – became established in Texas in 1990 and arrived in Southern California in Riverside County in October 1994. Currently, the entire counties of Imperial, Riverside, San Bernardino, Los Angeles, Orange, and San Diego are considered colonized as are parts of Ventura and Kern counties. There have been numerous reports of stinging incidents involving humans and pets, but there are no reports of human deaths related to AHB or bees in general here in California.

The Southern California counties have been working diligently to develop a response protocol to deal with the enormous numbers of calls received about bees. To complicate matters, responding agencies vary from county to county. These include fire departments, vector and mosquito abatement, health and agriculture departments. As AHB becomes fully established, public agencies may find that responding to calls about swarms and feral nests will quickly exhaust their resources.

Although its “killer” reputation has been greatly exaggerated, the presence of AHB will increase the chances of people being stung. Learning about the AHB and taking certain precautions can lower the risk of being injured by this new insect in our environment.

Copies of Bee Alert brochures are available through our office. These brochures contain AHB facts and recommended safety precautions. They are available in English, Spanish, Vietnamese, Cambodian, Laotian, Hmong, Chinese, and Korean. A single copy can be obtained by sending a SASE. A packet of 100 brochures can be purchased for \$6.50. Make checks payable to UC Regents.

### **General Precautions and Guidelines for Working in the Presence of AHB**

1. Be observant. Walk around the area to be worked and observe and listen for excessive bee activity.
2. Be aware of your surroundings and plan escape routes. If your vehicle or nearby buildings are locked, have keys readily accessible.
3. Never work alone.
4. Avoid wearing strong cologne, dark colors or leather.
5. Power equipment, i.e. tractors, weed eaters, mowers, and chain saws tend to disturb the AHB from greater distances. Once disturbed, they will summon other AHB from the hive and pursue you a great distance.
6. If attacked by any bee colony, retreat as rapidly as possible to an enclosed structure or vehicle. Water or thick vegetation does not offer enough protection. Do not stand and swat at bees; rapid motions will cause them to sting. Although some of the bees will follow you into an enclosure, it will be a smaller number than what is following behind. Air-conditioning will slow the bees' activity.
7. **Do not** attempt to exterminate the bee colony yourself. The techniques and equipment required for this task are beyond most individuals. Even professional exterminators receive specialized training in the handling of bees.
8. Contact the appropriate people. In the event of an immediate life threatening situation, call 911!. For non-life threatening events, contact the Agricultural Commissioner's office in your county.

### **What To Do If Stung**

1. Go quickly to a safe area.
2. Remove stinger as soon as possible, pulling out the stinger will not release more venom than if you scrape it out. The important thing is to get the stinger out fast.
3. Wash sting area with soap and water like any other wound.
4. Apply ice pack for a few minutes to relieve pain and swelling.
5. Seek medical attention if breathing is troubled, if stung numerous times or if allergic to bee stings.

## **WEED BARRIERS AND HERBICIDES FOR LANDSCAPE WEED CONTROL**

**Cheryl A. Wilen<sup>1</sup> and Dennis Pittenger<sup>2</sup>**

*<sup>1</sup>University of California Cooperative Extension, San Diego County, Statewide IPM Project  
5555 Overland Ave. Bldg. 4, San Diego, CA 92123*

*<sup>2</sup>University of California Cooperative Extension, Southern Region and Los Angeles County  
Dept. of Botany and Plant Sciences, University of California, Riverside, CA 92521-0124*

Weed control in the landscape is generally difficult due to the wide variety of plants (such as annuals and perennials, including herbaceous and woody plants) at a site. Public safety issues also influence weed control methods in landscapes. These areas are maintained for the public's enjoyment, consequently herbicides that require people be excluded from an area for an extended period, even a few hours, are not desirable.

We are currently examining various mulches for long term-weed control in landscape beds. A mulch is any material placed on the soil to cover and protect it. Mulches can suppress annual weeds by limiting light and oxygen required for weed seed germination. Most commonly used in landscape beds are bark and wood products and stones. Black plastic was often used below the mulch as the primary method of weed control but this limits root gas exchange and water penetration and many landscapers are moving away from this method of weed control.

More recently, geotextile fabrics have been available for weed management. These fabrics are porous, allowing water and air to pass through the material, overcoming the major disadvantage of black plastic. Compared to herbicide applications, these materials are relatively expensive and time-consuming to install, however, they can be cost-effective if the planting is to remain in place for 4 or more years. Geotextiles are used mainly for long term weed control in woody ornamental trees and shrubs. Where the site is replanted periodically such as in annual flowerbeds, geotextiles would be too expensive to use. Also, geotextiles are not recommended where the fabric would inhibit rooting and spread of ground covers.

Annual weeds become problematic if allowed to grow on or through the fabric. Controlled early, they are easily removed by hand as the mulch only lightly holds the roots. If left for a longer time, the roots may actually grow into the geotextile and a hole will be created when the weed is removed. This lessens the integrity of the geotextile and introduces an opening where weed seedlings can grow through.

We at the conclusion of a two year study examining both herbicides and geotextiles products for weed control in the landscape. Herbicide products included in our study are Gallery, Surflan, and Snapshot (a granular formulation of Gallery and Treflan). The landscape fabrics in the studies are Typar 3201G, Typar 3401G (a slightly heavier fabric), and Biobarrier. Biobarrier has the same fabric weight as Typar 3401G but has nodules filled with a Treflan formulation that is released over time.

We planted roses in July, 1997. All herbicides were applied to bare ground and all the fabrics were covered with chipped wood mulch from city landscaping to reduce photodegradation. We evaluated the weed cover, percent control, and plant vigor and found that overall, the mulched plots had more vigorous plants (Fig. 1) and less weeds than the control or the plots treated with herbicides (Fig. 2). We also found that there was less effort needed to maintain weed control with the plots covered with fabric. In the course of the study, we had to apply herbi-

cide at least two times per year, in addition to removing the weeds that had come up between herbicide application. The only maintenance we had to do on the mulched plots was to replenish the mulch once and remove the one or two weeds that started growing in the mulch. These weeds were very easily removed because they were growing in the bark mulch or on top of the fabric and could be "peeled" off.

**Plot Plan for Landscape Weed Control at UCR**

Rep 4	9	10	2	1	4	6	5	3	8	7
Rep 3	5	3	8	7	1	9	10	4	6	2
Rep 2	8	5	7	2	10	1	3	9	4	6
Rep 1	3	8	4	9	7	2	6	1	5	10

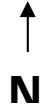

Treatment code:

- |  |  |
|--|--|
| 1. Gallery 1 lb a.i./A                 | 6. Biobarrier                                |
| 2. Surflan 4 lb a.i./A                 | 7. Typar 3201                                |
| 3. Gallery + Surflan (1 + 4 lb a.i./A) | 8. Typar 3401                                |
| 4. lery + Surflan (1 + 3 lb a.i./A)    | 9. Mulch alone                               |
| 5. Snapshot 5 lb a.i./A                | 10. Control (no herbicide, mulch, or fabric) |

Figure 1. Appearance of roses as affected by method of weed control.

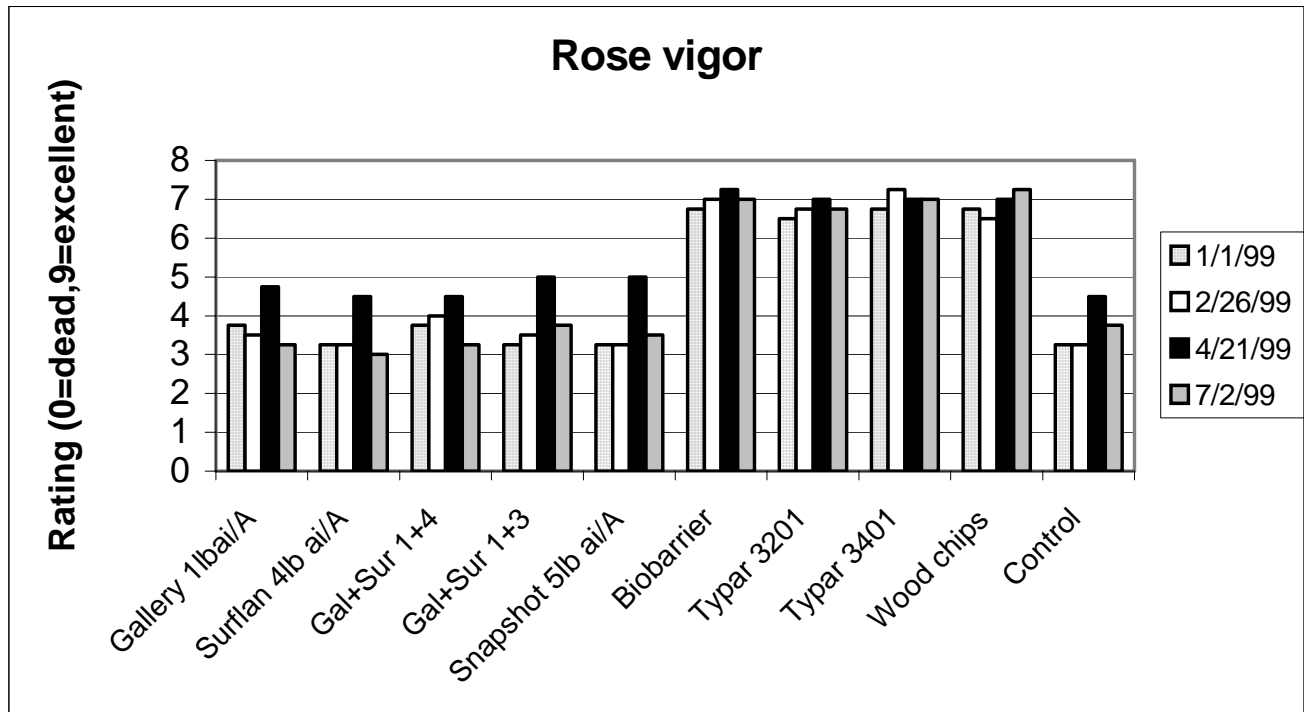
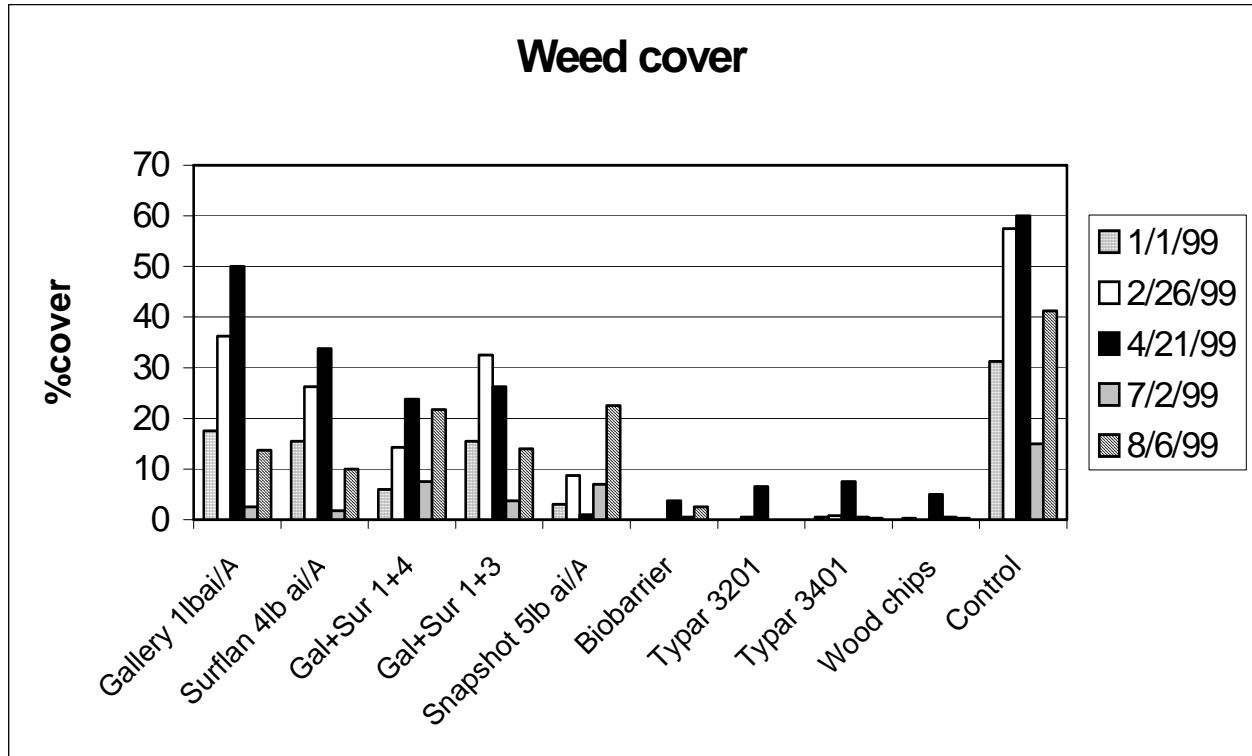

Figure 2. Percent weed cover. Weeds removed and herbicide re-applied on 11/15/98 and 6/4/98.



## **TECHNOLOGY FOR MEASURING SOIL WATER CONTENT AND POTENTIAL**

**Laosheng Wu<sup>1</sup> and William Richie<sup>2</sup>**

<sup>1</sup>*Dept. of Environmental Sciences, University of California, Riverside, CA 92521-0124*

<sup>2</sup>*Dept. of Botany and Plant Sciences, University of California, Riverside, CA 92521-0124*

The availability of water to plants can be measured in terms of soil water content (quantitatively), and soil water potential (qualitatively). A water retention curve is a plot of soil water content vs. tension, thus it relates these two parameters.

Soil water content measures the amount of water in the soil (volumetric and gravimetric). Methods of soil water content measurement include direct measurement by gravimetric sampling (with oven or microwave drying), and indirect measurements by neutron probe, time domain reflectometry (TDR), and capacitance probes. With neutron probe, fast neutrons from a radioactive source collide with hydrogen atoms in water and become 'thermalized', or slow neutrons. A detector counts the number of slow neutrons (per time) and this count is directly related to volumetric water content. TDR is based on the principle that a soil's dielectric constant is predominantly determined by liquid water. TDR measures the dielectric constant, which is related to volumetric water content through calibration equations. Capacitance probes also measure soil dielectric constant. Two electrodes in the probe and in the soil adjacent to the probe form a capacitor. The soil dielectric constant can be determined through measuring capacitance, which is then related to volumetric water content.

Soil water potential can be measured by either tensiometers or resistance blocks. Tensiometers are the most popular device for water management and careful preparation, installation, and maintenance are important to ensure proper function. Before installation, a vacuum should be applied overnight with the ceramic tips in water to prevent air entrapment. During installation, good contact between the porous cup and surrounding soil is important. An auger with a similar size to the tensiometer should be used, along with a soil slurry to ensure good soil-sensor contact. Regular maintenance includes vacuuming and refilling the tensiometer periodically. Watermark sensors and other resistance blocks measure the electrical conductivity or resistance between two electrodes embedded in gypsum or nylon blocks. Proper installation is also important, and calibration between conductivity or resistance in the sensor and soil matric potential/water content is needed to establish the relationship between them. Resistance blocks can only be used under conditions where salts do not affect the calibration curve unduly. Watermark sensors function in the soil water potential range similar to tensiometers (0 to -100 kPa), but can read down to a soil water potential of -200 kPa (-200 centibars). Gypsum blocks can be used under drier conditions than Watermarks or tensiometers, and are more sensitive for soil water potentials  $\leq$  -100 kPa (-100 centibars).



## WEEDS IN ORNAMENTALS

David W. Cudney

Dept. of Botany and Plant Sciences, University of California, Riverside, CA 92521-0124

Weeds in ornamental plantings can become an unsightly mess. In severe cases they can crowd out desirable species and completely take over a planting. Years ago we had little that we could do to combat these costly invaders other than hand removal or complete renovation of the site. We now have a better means of control. First off, we have better adapted ornamental species that are more competitive with weeds, numerous mulches to discourage weed germination and growth, and a few herbicides, which can discourage weed germination or aid in recovery of weedy sites.

Why are weeds problems in ornamental sites? They fill voids where stresses from heavy use, improper management, disease, or insect attack have left openings for weeds to develop. The old adage that nature abhors a vacuum is certainly true in groundcovers and woody ornamentals where the "vacuum" is quickly filled with weeds. Even with the best varieties and management practices, openings for weed invasion may occur. This is where mulches, preemergent (PRE) and postemergent (POST) herbicides can help to temporarily eliminate weeds and aid in the reestablishment of a healthy, competitive ornamental cover.

### WEEDS

Three annuals, which often become problems in ornamental plantings, are annual bluegrass (*Poa annua*), crabgrass (*Digitaria spp.*) and spurge (*Euphorbia supina*). Annual bluegrass is a low-growing, winter annual that generally infests ornamentals in the fall and winter months dying off in the late spring and summer. It is a prolific seeder and can produce a low sod of weed growth rapidly.

Two species of crabgrass are common (large, *D. sanguinalis*, and smooth crabgrass, *D. ischaemum*). Both species are summer annuals that spread primarily by seed, and to a lesser extent, by rooting at swollen nodes along their stems. Crabgrass is frequently a problem in overirrigated sites. Frequent, shallow irrigation encourages the establishment of crabgrass.

Both annual bluegrass and crabgrass can be controlled with preemergence herbicides if the herbicide application is timed prior to emergence of the weeds. In most areas of California this would be in late February for crabgrass and in early September for annual bluegrass. Postemergence grass herbicides are available for the control of crabgrass in ornamentals but annual bluegrass is only controlled by grass herbicides containing clethodim (check labels of all herbicides you are contemplating use of for compatibility with your ornamental species).

The common name for spurge varies with location and there is no clear consensus on the name in published sources. It is generally called either spotted spurge or prostrate spurge. Prostrate spurge is the generally accepted name. Prostrate spurge is an annual that begins germination in early summer and continues to germinate through July and August. It can be controlled with various preemergence herbicides. The reason that it makes the list of worst weeds is a timing problem. If preemergence herbicides are applied early enough, they generally lose their efficacy before the spurge germinates. The spurge begins to appear in midsummer at a time that is not conducive to applications of postemergence herbicides because of the risk of damage to



other landscape plants. This weed is one of the primary reasons for 'call backs' in the landscape industry. Callbacks are an expensive nuisance and there is presently no good solution to the problem.

Three of the most serious perennial weeds are bermudagrass (*Cynodon dactylon*), oxalis (*Oxalis corniculata*), and nutsedge (*Cyperus spp.*).

Common bermudagrass is commonly used as a warm-season turf, but it is also a difficult perennial weed in ornamentals in the warmer climates of the west. It spreads by seed and by stem sections (rhizomes and stolons). The rhizomes and stolons are many jointed and root at the nodes. Bermudagrass does not grow well in the shade preemergence herbicides will aid in the control of germinating bermudagrass seedlings. Repeated applications of postemergence grass control herbicides can reduce established bermudagrass.

Oxalis or creeping woodsorrel is a perennial that is often a serious problem in ornamental plantings. Oxalis grows year round producing running rootstocks and leaves similar to those of clover. There are no cultural controls available for this weed. Herbicides that control *Oxalis stricta* (an annual found in many southern states) do not control creeping woodsorrel. Preemergence treatment with herbicides containing pendimethalin, or isoxaben will limit emergence. Selective application of glyphosate as a spot treatment is helpful but care must be exercised to avoid the foliage of desirable plants.

Yellow (*Cyperus esculentus*) and purple nutsedge (*C. rotundus*) are serious perennial weeds in ornamentals. Yellow nutsedge is found extensively in California while purple nutsedge is limited to the warmest regions. Both produce an extensive system of underground tubers from which they can regenerate. Nutsedge is very difficult to control once it is established. When establishing ornamental plantings, plant in seedbeds that are free of nutsedge. Small, localized infestations of nutsedge, can be reduced non-selectively with metham fumigation or repeated applications of glyphosate. Yellow nutsedge may be reduced in by multiple postemergence applications of glyphosate if care is exercised to avoid the foliage of desirable plants.

There are many more (over 200) weed species which can become problems in ornamental plantings in California. The first line of defense against these invaders is to maintain a healthy, competitive cover of landscape ornamentals. Mulching with landscape fabrics can be helpful particularly for controlling annuals and seedlings of perennial species. Fabric should be overlapped so that no light is allowed to penetrate to the soil. Use a polypropylene or polyester fabric or black polyethylene (plastic tarp) to block all plant growth. Fabric mulches can be covered with an organic mulch to improve esthetics. Organic mulches may also be effective by themselves if they are maintained at a depth of at least 3 inches and are managed in such a way as to not provide a growth media for new weed seedlings. Herbicides can be used to supplement good cultural practices when necessary.

## **EVALUATION OF LANDSCAPE TREE SPECIES**

**Donald R. Hodel<sup>1</sup> and Dennis R. Pittenger<sup>1, 2</sup>**

*<sup>1</sup>University of California Cooperative Extension, Los Angeles County  
2 Coral Circle, Monterey Park, CA 91755*

*<sup>2</sup>University of California Cooperative Extension, Southern Region  
Dept. of Botany and Plant Sciences, University of California, Riverside, CA 92521-0124*

There is very little objective, scientifically based information on either the quantitative water needs of urban landscape tree species or the adaptability of the numerous small to medium-sized tree species that are reportedly suited to the inland climate. Thus, there is a need to conduct controlled field studies on the horticultural qualities and growth responses of a large number of small to medium tree species when they are grown in inland valleys of Southern California.

***The overall objectives of this study are to:***

1. Determine the adaptability, performance, and horticultural qualities of selected temperate and xerophytic tree species when maintained at 80% and 35% of reference ET in non-desert interior valleys of Southern California.
2. Identify tree species that will serve well as medium-sized landscape trees in the non-desert interior valleys of Southern California.

***Some of the specific questions that this project is expected to answer at its conclusion are:***

1. Which tree species grow and perform acceptably well as landscape plants in this climate zone?
2. Which tree species in this study performed best and which one(s) performed worst?
3. Which tree species grow and perform acceptably when provided very limited irrigation (35% of reference ET)?
4. Which species grow the fastest?
5. What are the horticultural characteristics of assorted tree species when grown in this climate zone, and are these characteristics affected by irrigation amount?

Trees have been evaluated for performance (growth, visual, and horticultural characteristics) under 35% and 80% ET<sub>o</sub> irrigation regimes since March 1, 1996.

***Data Collected:***

1. Trees are rated monthly for the following visual and horticultural characteristics:
  - a. Overall tree vigor measured on a 0-5 scale with 0 = dead and 5 = rank growth.

- b. Overall tree attractiveness measured on a 0-5 scale with 0 = dead and 5 = outstanding appearance.
  - c. Tree canopy density measured on a 0-5 scale with 0 = no foliage and 5 = very dense, complete shade.
  - d. Fruit density measured on a 0-5 scale with 0 = none and 5 = very profuse.
  - e. Flower rating measure on a 0-5 scale with 0 = none and 5 = very profuse.
  - f. Litter rating measured on a 0-5 scale with 0 = none and 5 = complete coverage of soil.
  - g. Pest rating (insects) measured on a 0-5 scale with 0 = none and 5 = severe infestation or high incidence.
- 2. Tree caliper (trunk diameter) measured semi-annually-February and August-15 cm above the soil surface.
  - 3. Tree height measured semi-annually February and August from soil surface to the top of the tree canopy.

Other monthly visual assessments of tree performance and appearance are:

1) foliage color, 2) foliage size, 3) foliage showiness, 4) flower size, 5) flower color, 6) flower showiness, 7) fruit color, 8) fruit size, 9) fruit showiness, 10) diseases, 11) response to abiotic factors.

Table 1. List of Tree Species Evaluated in alphabetical order<sup>1</sup>.

**E = Evergreen**

**D = Deciduous**

---

1. Acacia melanoxylon	E	
2. Agonis flexuosa	E	
3. Acer palmatum	D	
4. Acer platanoides 'Deborah'	D	(Removed in 1997)
5. Acer rubrum 'Red Sunset'	D	
6. Arbutus unedo	E	
7. Bauhinia variegata - multi	D	(Replaced Cornus kousa in 1995)
8. Brachychiton acerifolius	E	
9. Callistemon viminalis	E	
10. Crataegus phaenopyrum	D	
11. Crinodendron patagua	E	(Replaced Pittosporum in 1995, removed 1997)
12. Eriobotrya deflexa	E	
13. Eucalyptus torquata	E	
14. Geijera parviflora	E	(Removed in 1998)
15. Ginkgo biloba 'Autumn Gold'	D	(Removed in 1998)
16. Gleditsia triacanthos inermis 'Aurea'	D	
17. Hymenosporum flavum	E	(Removed in 1995)
18. Koelreuteria bipinnata	D	
19. Ligustrum lucidum	E	
20. Liquidambar styraciflua 'Burgundy'		(Deciduous standard)
21. Magnolia grandiflora 'Majestic Beauty'		(Evergreen standard)
22. Malus floribunda 'Robinson'	D	
23. Maytenus boaria	E	
24. Metrosideros excelsus	E	(Removed in 1995)
25. Nyssa sylvatica	D	(Removed in 1998)
26. Parkinsonia aculeata	D	
27. Pinus thunbergiana	E	
28. Prunus persica 'Early Red'	D	
29. Quercus ilex	E	
30. Robinia ambigua 'Idahoensis'	D	
31. Sapium sebiferum	D	
32. Sophora japonica	D	
33. Sorbus hupehensis 'Coral Fire'	D	(Removed 1997)
34. Tilia cordata 'Greenspire'	D	
35. Tipuana tipu	D	
36. Zelkova serrata 'Village Green'	D	
37. Zizyphus jujuba 'Lang'	D	

Updated 8/99

---

<sup>1</sup>Note: This is not the order used for original tree identification numbers.

**Table 2. The effect of irrigation treatment and tree species on % caliper change and % height change between 1996-1999.**

Treatments	% Caliper Change 1996-1999	% Height Change 1996-1999	Treatment	% Caliper Change 1996-1999	% Height Change 1996-1999
<b>Irrigation</b>			<b>Irrigation</b>		
80%	104.5	51.7	80%	136.7	45.7
35%	87.3	39.4	35%	97.6	29.2
LSD, $P < 0.05$	NS	NS	LSD, $P < 0.05$	NS	NS
<b>Deciduous species</b>			<b>Evergreen species</b>		
Parkinsonia	198.7 a	71.0 bc	Brachychiton	68.3 c	32.7cde
Tipuana	160.2 ab	50.5 cde	Ligustrum	114.3 bc	22.2 de
Sapium	132.7 bc	55.2 cd	Geijera	136.0 abc	69.8 ab
Sophora	121.7 bcde	45.8 de	Acacia	85.9 c	25.5 cde
Koelreuteria	97.9 cdef	42.0 efg	Eucalyptus	197.1 a	72.6 a
Robinia	126.3 bcd	80.9 ab	Callistemon	116.5 bc	41.2 cd
Zelkova	109.0 cde	53.1 cd	Quercus	186.8 a	34.1 cde
Zizyphus	75.8 efg	63.0 bcd	Arbutus	154.3 ab	10.1 e
Gleditsia	98.9 cdef	80.6 ab	Pinus	74.8 c	44.6 bcd
Prunus	61.9 fgh	27.3 efg	Magnolia <sup>Y</sup>	71.6 c	51.0 abc
Liquidambar <sup>Z</sup>	83.2 def	47.6 cde	Eriobotrya	81.4 c	8.2 e
Bauhinia	158.1 ab	102.9 a	LSD, $P < 0.05$	68.2	26.0
Acer rubrum	30.9 gh	13.4 gh	<b>Summary of ANOVA effects<sup>x</sup></b>		
Acer palmatum	78.7 ef	19.7 fgh	Irrigation (I)	NS	NS
Tilia	27.3 h	5.5 gh	Species (S)	***	***
Malus	27.3 h	2.3 h	I x S	NS	NS
Crataegus	28.8 h	13.2 gh			
LSD, $P < 0.05$	46.1	23.6			
<b>Summary of ANOVA effects<sup>x</sup></b>					
Irrigation (I)	NS	NS			
Species (S)	***	***			
I x S	NS	*			

<sup>Z</sup>Standard deciduous species.

<sup>Y</sup>Standard evergreen species.

<sup>x</sup>Split-plot statistical design.

NS, \*, \*\*, \*\*\* = Nonsignificant, or significant at  $P_{0.05}$ , 0.01, or 0.001, respectively.